



# INDUSTRIAL AIR TOOLS PRODUCT CATALOG



ENGINEERED  
TO BE  
FEARLESS





# AMERICAN MADE SINCE 1914



From raw material to final assembly, Sioux Tools have been designed, engineered and manufactured in the USA for over 100 years.

Our facility in Murphy, NC manufactures pneumatic drills, screwdrivers, impacts, grinders, sanders, and many specialty tools that serve a wide range of industries. We are committed to quality, reliability, and customer satisfaction.

**Sioux Tools are truly "*Engineered to be Fearless!*"**



# PRODUCTS THAT DELIVER VALUE



**Snap-on Incorporated**

## Who We Are

### OUR MISSION

The most valued productivity solutions in the world

BELIEFS	VALUES	VISION
<p>We deeply believe in:</p> <ul style="list-style-type: none"><li>Non-negotiable Product and Workplace Safety</li><li>Uncompromising Quality</li><li>Passionate Customer Care</li><li>Fearless Innovation</li><li>Rapid Continuous Improvement</li></ul>	<p>Our behaviors define our success:</p> <ul style="list-style-type: none"><li>We demonstrate Integrity.</li><li>We tell the Truth.</li><li>We respect the Individual.</li><li>We promote Teamwork.</li><li>We Listen.</li></ul>	<p>To be acknowledged as the:</p> <ul style="list-style-type: none"><li>Brands of Choice</li><li>Employer of Choice</li><li>Franchisor of Choice</li><li>Business Partner of Choice</li><li>Investment of Choice</li></ul>

**Non-negotiable Product and Workplace Safety.**

**From the manufacturer to the user, safety is paramount. We put extra margin of safety into every tool we make.**

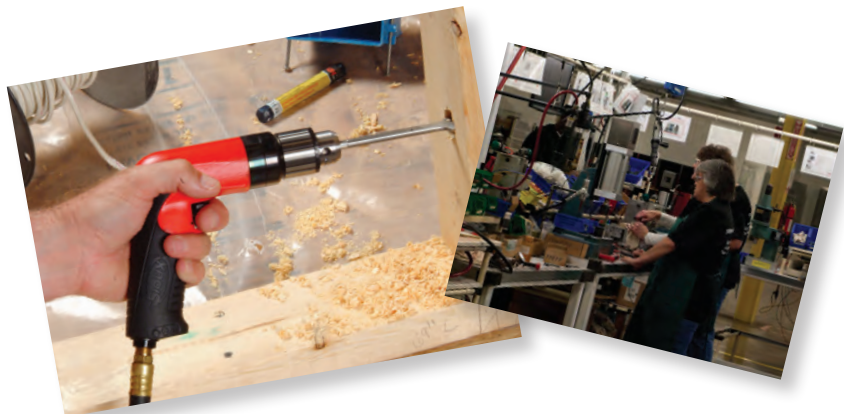



# CATALOG INDEX

<b>DRILLS</b> .....	<b>9</b>
DRILLS .....	12 – 18
DRILL ACCESSORIES .....	19
<b>ASSEMBLY</b> .....	<b>20</b>
SCREWDRIVERS .....	25 – 29
NUTRUNNERS .....	30
RATCHET WRENCHES .....	31
IMPACT DRIVERS .....	33
IMPACT WRENCHES .....	34 – 35
ASSEMBLY ACCESSORIES .....	36
<b>ABRASIVE</b> .....	<b>37</b>
GRINDERS .....	39 – 49
CUTOFF TOOLS .....	50
ABRASIVE ACCESSORIES .....	51
<b>FINISHING</b> .....	<b>52</b>
SANDERS .....	54 – 58
POLISHERS .....	59
FINISHING ACCESSORIES .....	60 – 62
<b>PERCUSSIVE</b> .....	<b>63</b>
SCALERS .....	65 – 66
HAMMERS .....	66
PERCUSSIVE ACCESSORIES .....	67 – 69
<b>SPECIALTY</b> .....	<b>70</b>
ROUTERS .....	72
CLINCH NUT TOOLS .....	74
TAPPERS .....	75
RIVET SHAVERS .....	75
SKIN CLAMP RUNNERS .....	76
SAWS .....	76 – 77
NIBBLERS & SHEARS .....	77
AEROSPACE .....	79 – 80
SPECIALTY ACCESSORIES .....	81 – 82
<b>GENERAL ACCESSORIES</b> .....	<b>83 – 84</b>



# SIOUX TOOLS INDUSTRIAL CATALOG | MODEL NUMBER INDEX

MODEL	PAGE	MODEL	PAGE	MODEL	PAGE	MODEL	PAGE	MODEL	PAGE
1238L	59	3A1140	17	IW75BP-6H	34	SAG03S20M6	43	SAS10A152-20	57
1285L	47	3A1240	17	IW75BP-8H	34	SAG03S20M6S	43	SAS10A182-20	57
1287L	58	3A1530	17	IW750MP-6H	34	SAG03S20S	43	SAS10A324	57
1290	58	3A2102	30	IW750MP-6P	34	SAG05S12	43	SAS10A607	58
1290L	58	3A2104	30	IW750MP-6PT	35	SAG05S12M6	43	SAS10AX125	58
1291	48	3A2108	30	IW750MP-6R	34	SAG05S12M6S	43	SAS10S125	58
1291L	48	3A2140	17	PS690	56	SAG05S12S	43	SAS10S905	58
1292	59	3A2208	30	RO2510-44FNC	55	SAG05S15	43	SAS10SX125	58
1292L	59	3A2240	17	RO2512-30FNH	54	SAG05S15M6	43	SC3PA	66
1296	59	3A2340	17	RO2512-30FNP	54	SAG05S15M6S	43	SC3PA-C	66
1300	76	3A2430	17	RO2512-30FRH	54	SAG05S15S	43	SC41011AL-C	65
1420	15	3P1140	13	RO2512-30FRP	54	SAG05S18	43	SC41011AL-K	65
1464	17	3P1240	13	RO2512-30FVH	54	SAG05S18M6	43	SC41011AL-N5	65
1465	17	3P1340	13	RO2512-30FVP	54	SAG05S18M6S	43	SC41011AU-C	65
1465-1/2	17	3P1430	13	RO2512-30SNH	54	SAG05S18S	43	SC41011AU-N5	65
1466	17	3P1530	13	RO2512-30SNP	54	SAG05S23	43	SC80910AL-C	65
14S2500SR	76	3P1540	13	RO2512-30SRH	54	SAG05S23M6	43	SC80910AL-K	65
1980	72	3P1640	13	RO2512-30SRP	54	SAG05S23M6S	43	SC80910AL-N5	65
1980A	72	3P2140	14	RO2512-30SVH	54	SAG05S23S	43	SCN12R	74
1981F	72	3P2340	14	RO2512-30SVP	54	SAG10AX12	44	SCN20R	74
1982A	72	3T1140	18	RO2512-35FNH	54	SAG10AX12M6	44	SCN25R	74
1985A	42	3T1340	18	RO2512-35FNP	54	SAG10AX15	44	SCN3R	74
1985-1/2	42	3T1530	18	RO2512-35FRH	54	SAG10AX15M6	44	SCN5R	74
1AM1141/51K	16	3T1630	18	RO2512-35FRP	54	SAG10AX18	44	SCN7R	74
1AM1141SRK	16	3T1640	18	RO2512-35FVH	54	SAG10AX18M6	44	SCO10A106	50
1AM1151	16	3T2303	25	RO2512-35FVP	54	SAG10S12	43	SCO10A125	50
1AM1151SRK	16	658	56	RO2512-35SNH	54	SAG10S12M6	43	SCO10A184	50
1AM1441	16	697	56	RO2512-35SNP	54	SAG10S15	43	SCO10AX124	50
1AM1451	16	CH42A-H	66	RO2512-35SRH	54	SAG10S15M6	43	SCO10S184F	50
1AM1452	16	CH42A-R	66	RO2512-35SRP	54	SAG10S18	43	SCO10S184R	50
1AM1541	16	CH43A-H	66	RO2512-35SVH	54	SAG10S18M6	43	SCO10S204F	50
1AM1551	16	CH43A-R	66	RO2512-35SVP	54	SAG7AX13	44	SCO10S204R	50
1AM1552	16	CH44A-H	66	RO2512-50CNH	54	SAG7AX13M6	44	SCO10S253F	50
1AM2101	29	CH44A-R	66	RO2512-50CNP	54	SAG7AX16	44	SCO10S253R	50
1AM2102	30	DR1422	15	RO2512-50CRH	54	SAG7AX16M6	44	SCO7A184	50
1AM2105	29	DR1467	17	RO2512-50CRP	54	SAG7AX20	44	SCO7AX184	50
1AM2106	30	DR3P2240	14	RO2512-50CVH	54	SAG7AX20M6	44	SCOA1AX124	50
1AM2201	29	GO459-60SNH	55	RO2512-50CVP	54	SAG7S12	43	SCOA1AX124G	50
1AM2205	29	GO459-60SNP	55	RO2512-50FNH	54	SAG7S12M6	43	SCOS1AX124	50
1AML1451	16	GO459-60SRH	55	RO2512-50FNP	54	SAG7S15	43	SCOS1AX124G	50
1AML1541	16	GO459-60SRP	55	RO2512-50FRH	54	SAG7S15M6	43	SDG03S25	39
1AML1551	16	GO459-80SNH	55	RO2512-50FRP	54	SAG7S18	43	SDG03S25M6	39
1OT2108Q	28	GO459-80SNP	55	RO2512-50FVH	54	SAG7S18M6	43	SDG03S25M6S	39
1OT2208Q	28	GO459-80SRH	55	RO2512-50FVP	54	SAGA1AX12	45	SDG03S25S	39
1OT2308Q	28	GO459-80SRP	55	RO2512-50SNH	54	SAGA1AX12G	45	SDG05S18	39
1OT2508Q	28	HG20AL-45S8	49	RO2512-50SNP	54	SAGA1AX12M6	45	SDG05S18M6	39
1SM2103	26	HG20AL-60S6	49	RO2512-50SRH	54	SAGA1AX12M6G	45	SDG05S18M6S	39
1SM2105Q	28	HG20AL-80P3	49	RO2512-50SRP	54	SAGA1AX15	45	SDG05S18S	39
1SM2107	27	HG30AL-45S8	49	RO2512-50SVH	54	SAGA1AX15G	45	SDG05S23	39
1SM2205Q	28	HG30AL-60S6	49	RO2512-50SVP	54	SAGA1AX15M6	45	SDG05S23M6	39
1SM2305Q	28	HG30AL-80P3	49	RO2512-60CNH	54	SAGA1AX15M6G	45	SDG05S23M6S	39
1SM2405	28	ID375AP-2Q	33	RO2512-60CNP	54	SAGA1AX18	45	SDG05S23S	39
1SM2405Q	28	ID375AP-2QRR	33	RO2512-60CRH	54	SAGA1AX18G	45	SDG10P18	56
1SM2407	27	IW100HAI-5S	35	RO2512-60CRP	54	SAGA1AX18M6	45	SDG10P21	56
1ST2108Q	28	IW100HAI-5S6	35	RO2512-60CVH	54	SAGA1AX18M6G	45	SDG10S12F	39
1ST2208Q	28	IW100HAI-8H	35	RO2512-60CVP	54	SAGS1AX12	45	SDG10S12M6F	39
1ST2308Q	28	IW100HAI-8H6	35	RO2512-60FNH	54	SAGS1AX12G	45	SDG10S12M6R	39
1ST2508Q	28	IW100HAO-5S	35	RO2512-60FNP	54	SAGS1AX12M6	45	SDG10S12R	39
270A	66	IW100HAO-5S6	35	RO2512-60FRH	54	SAGS1AX12M6G	45	SDG10S18F	39
270A-2	66	IW100HAO-8H	35	RO2512-60FRP	54	SAGS1AX15	45	SDG10S18M6F	39
270A-4	66	IW100HAO-8H6	35	RO2512-60FVH	54	SAGS1AX15G	45	SDG10S18M6R	39
2S1310	18	IW1000MP-8H	35	RO2512-60FVP	54	SAGS1AX15M6	45	SDG10S18R	39
2S1330	18	IW1000MP-8H5	35	RO2512-60SNH	54	SAGS1AX15M6G	45	SDG10S25F	39
2S2103AQ	29	IW1000MP-8H8	35	RO2512-60SNP	54	SAGS1AX18	45	SDG10S25M6F	39
2S2103Q	29	IW150HAI-12H	35	RO2512-60SRH	54	SAGS1AX18G	45	SDG10S25M6R	39
2S2105Q	29	IW150HAI-5S	35	RO2512-60SRP	54	SAGS1AX18M6	45	SDG10S25R	39
2S2107	29	IW150HAO-12H	35	RO2512-60SVH	54	SAGS1AX18M6G	45	SDG10SHT08	42
2S2110	18	IW150HAO-5S	35	RO2512-60SVP	54	SAP10A327	59	SDG10SHT08M6	42
2S2130	18	IW375AP-3F	33	RS10K	77	SAP10A457	59	SDG10SHT12	42
2S2203AQ	29	IW375AP-3P	33	RT1981	72	SAP10S227	59	SDG10SHT12M6	42
2S2207	29	IW38TBP-2Q	33	RT1982	72	SAS03S122-20	57	SDG7S18F	39
2S2230	18	IW38TBP-3P	33	RT1983	72	SAS03S202-20	57	SDG7S18M6F	39
2S2300SR	76	IW500MP-4P	34	RT1985	42	SAS05S122-20	57	SDG7S25F	39
2S2303AQ	29	IW500MP-4P3	34	SAG03S12	43	SAS05S152-20	57	SDG7S25FS	39
2S2305Q	29	IW500MP-4PT	35	SAG03S12M6	43	SAS05S182-20	57	SDG7S25M6F	39
2S2307	29	IW500MP-4R	34	SAG03S12M6S	43	SAS05S232-20	57	SDGA1S12	40
2S2310	18	IW500MP-4R3	34	SAG03S12S	43	SAS10A122-20	57	SDGA1S12G	40
2S2330	18	IW500MP-7Q	34	SAG03S20	43	SAS10A125	58	SDGA1S12M6	40



# MODEL NUMBER INDEX | SIOUX TOOLS INDUSTRIAL CATALOG

MODEL	PAGE	MODEL	PAGE	MODEL	PAGE	MODEL	PAGE	MODEL	PAGE
SDGA1S12M6G	40	SDR10P40R2	14	SDR5P30R2	13	SSD10A16S	29	STP10S7B12	75
SDGA1S18	40	SDR10P40R3	14	SDR5P33R2	13	SSD10A20S	29	STXG10S12	41
SDGA1S18G	40	SDR10P40RK3	14	SDR5P36N2	12	SSD10A3S	29	STXG10S12M6	41
SDGA1S18M6	40	SDR10P4N3	12	SDR5P3R2	13	SSD10A5S	29	STXG10S18	41
SDGA1S18M6G	40	SDR10P4N4	12	SDR5P43N2	12	SSD10A6S	29	STXG10S18CW	41
SDGA1S25	40	SDR10P4NK4	13	SDR5P50N2	12	SSD10P12AC	27	STXG10S18M6	41
SDGA1S25G	40	SDR10P5R3	14	SDR5P5N2	12	SSD10P12P	25	STXG10S23	41
SDGA1S25M6	40	SDR10P5R4	14	SDR5P5R2	13	SSD10P12PS	25	STXG10S23M6	41
SDGA1S25M6G	40	SDR10P5R4RR	14	SDR5P7N2	12	SSD10P12S	26	SWG05S183	47
SDGS1S12	40	SDR10P5RK4	14	SDR5P8N2	12	SSD10P20AC	27	SWG10A124	47
SDGS1S12G	40	SDR10P60N2	13	SDR5P8R2	13	SSD10P20P	25	SWG10A124S	47
SDGS1S12M6	40	SDR10P60N3	13	SDR6P12N3	12	SSD10P20PRR	25	SWG10A125	47
SDGS1S12M6G	40	SDR10P60NK3	13	SDR6P20R3RR	14	SSD10P20PS	25	SWG10AX124	46
SDGS1S18	40	SDR10P7N3	12	SDR6P20RK3RR	14	SSD10P20S	26	SWG10AX124S	46
SDGS1S18G	40	SDR10P7N4	12	SDR6P20RK4RR	14	SSD10P20SRR	26	SWG10AX125	46
SDGS1S18M6	40	SDR10P7NK4	13	SDR6P25R3RR	14	SSD10P25AC	27	SWG10AXL124	46
SDGS1S18M6G	40	SDR10P7R3	14	SDR6P25RK3RR	14	SSD10P25P	25	SWG10S106	47
SDGS1S25	40	SDR10P7R4	14	SDR6P25RK4RR	14	SSD10P25PRR	25	SWG10S124	47
SDGS1S25G	40	SDR10P7RK4	14	SDR6P26N2	12	SSD10P25PS	25	SWG10S124S	47
SDGS1S25M6	40	SDR10P7RK4R	15	SDR6P26N3	12	SSD10P25S	26	SWG10S125	47
SDGS1S25M6G	40	SDR10S12N3	15	SDR6P26N4	12	SSD10P3AC	27	SWG10S183	47
SDR10A10N3	17	SDR10S12R3	15	SDR6P26NK3	12	SSD10P3S	26	SWG7AX134	46
SDR10A10N4	17	SDR10S12R4	15	SDR6P3N2	12	SSD10P5AC	27	SWG7AX134S	46
SDR10A10R3	17	SDR10S16N3	15	SDR6P40N2	12	SSD10P5S	26	SWG7AX203	46
SDR10A10R4	17	SDR10S180N2	15	SDR6P40N3	12	SSD10P7AC	27	SWG7S183	47
SDR10A13N2	17	SDR10S20R2	15	SDR6P40NK3	12	SSD10P7S	26	SWG1AX124	46
SDR10A13N3	17	SDR10S20R3	15	SDR6P4N3	12	SSD10S12AC	28	SWG1AX124S	46
SDR10A16R2	17	SDR10S20R4	15	SDR6P4N4	12	SSD10S12S	27	SWG1AX1245G	46
SDR10A16R3	17	SDR10S210N2	15	SDR6P60N2	12	SSD10S20AC	28	SWG1AX124G	46
SDR10A20R2	17	SDR10S25R2	15	SDR6P60N3	12	SSD10S20S	27	SWG1AX124	46
SDR10A20R3	17	SDR10S25R3	15	SDR6P60NK3	12	SSD10S25AC	28	SWG1AX124S	46
SDR10A22N2	17	SDR10S26N2	15	SDR6P7N3	12	SSD10S25S	27	SWG1AX1245G	46
SDR10A22N3	17	SDR10S26N3	15	SDR6P7N4	12	SSD10S3AC	28	SWG1AX124G	46
SDR10A30N2	17	SDR10S3R3	15	SDR6P7NK3	12	SSD10S3S	27	XXG05S18	41
SDR10A3R3	17	SDR10S3R4	15	SDR6P7RK4RR	14	SSD10S5AC	28	XXG05S18M6	41
SDR10A3R4	17	SDR10S40N2	15	SMR05S354	49	SSD10S5S	27	XXG05S18M6S	41
SDR10A4N3	17	SDR10S40N3	15	SNH10S18	77	SSD10S7AC	28	XXG05S18S	41
SDR10A4N4	17	SDR10S40R2	15	SNR10A10S	30	SSD10S7S	27	XXG05S23	41
SDR10A6R3	17	SDR10S40R3	15	SNR10A16S	30	SSD4P11AC	27	XXG05S23M6	41
SDR10A6R4	17	SDR10S4N3	15	SNR10A20S	30	SSD4P11P	25	XXG05S23M6S	41
SDR10AH35	16	SDR10S4N4	15	SNR10A3S	30	SSD4P11S	26	XXG05S23S	41
SDR10P12N3	12	SDR10S5R3	15	SNR10A5S	30	SSD4P14AC	27	SZEA3000	80
SDR10P12N4	12	SDR10S5R4	15	SNR10A6S	30	SSD4P14P	25	SZEA3015	80
SDR10P12NK3	13	SDR10S60N2	15	SPS10P6	56	SSD4P14S	26	SZEA5000	79
SDR10P12R3	14	SDR10S60N3	15	SPS10P18	56	SSD4P18AC	27	SZEA5015	79
SDR10P12R4	14	SDR10S7N3	15	SRS10P21-10	75	SSD4P18P	25	SZEA5022	79
SDR10P12RK4	14	SDR10S7R3	15	SRS10P21-5	75	SSD4P18S	26	SZEA5030	79
SDR10P16N3	12	SDR10S7R4	15	SRS10P21-6	75	SSD4P26AC	27	SZEA6000	80
SDR10P16N4	12	SDR10T12N4	18	SRS10P21-7	75	SSD4P26P	25	SZEA6015	80
SDR10P180N2	13	SDR10T16N4	18	SRS10P21-8	75	SSD4P26S	26	SZEA7000	79
SDR10P20R2	14	SDR10T26N3	18	SRS10P21-9	75	SSD4P5AC	27	SZEA7015	79
SDR10P20R3	14	SDR10T26N4	18	SRS10P21-X-9W	75	SSD4P5P	25	SZEA7022	79
SDR10P20R3RR	14	SDR10T4N4	18	SRS10S21-8	75	SSD4P5S	26	SZEA7030	79
SDR10P20R4	14	SDR10T40N3	18	SRS6P21-10	75	SSD4P7AC	27	SZEA7030HP	79
SDR10P20RK3	14	SDR10T7N4	18	SRS6P21-5	75	SSD4P7P	25	SZEA8000	80
SDR10P20RK3R	15	SDR4P12N2	12	SRS6P21-6	75	SSD4P7S	26	SZEA8015	80
SDR10P20RK4	14	SDR4P18R2	13	SRS6P21-7	75	SSD6P12AC	27	SZEA9000	79
SDR10P20RK4R	15	SDR4P20R2	13	SRS6P21-8	75	SSD6P12P	25	SZEA9015	79
SDR10P210N2	13	SDR4P24R2	13	SRS6P21-9	75	SSD6P12S	26	SZEA9022	79
SDR10P25R2	14	SDR4P26N2	12	SRS6P21-9W	75	SSD6P20AC	27	SZEA9030	79
SDR10P25R3	14	SDR4P30N2	12	SRT10S18B	72	SSD6P20P	25	VG20AL-45D9	48
SDR10P25R3RR	14	SDR4P30R2	13	SRT10S18BB	72	SSD6P20PSRR	25	VG20AL-60C6	48
SDR10P25R4RR	14	SDR4P33R2	13	SRT10S18LT	72	SSD6P20S	26	VG20AL-60D7	48
SDR10P25RK3	14	SDR4P36N2	12	SRT10S18M6B	72	SSD6P20SRR	26	VG20AL-60D9	48
SDR10P25RK3R	15	SDR4P3R2	13	SRT10S18M6N	72	SSD6P25AC	27	VG30AL-45D7	48
SDR10P25RK4R	15	SDR4P43N2	12	SRT10S18N	72	SSD6P25P	25	VG30AL-45D9	48
SDR10P26N2	12	SDR4P50N2	12	SRT10S25B	72	SSD6P25PSRR	25	VG30AL-60C6	48
SDR10P26N3	13	SDR4P5N2	12	SRT10S25BB	72	SSD6P25S	26	VG30AL-60D7	48
SDR10P26N4	13	SDR4P5R2	13	SRT10S25LT	72	SSD6P7AC	27	VG30AL-60D9	48
SDR10P26NK3	13	SDR4P8N2	12	SRT10S25M6B	72	SSD6P7S	26	VS20AL-609	58
SDR10P26NK4	13	SDR4P8R2	12	SRT10S25M6N	72	SSH10P18	77	VS20AL-727	58
SDR10P26NL4	13	SDR5P12N2	12	SRT10S25N	72	SSH10S18	77		
SDR10P3R3	14	SDR5P18R2	13	SRW03S-25	31	SSR6P25	76		
SDR10P3R4	14	SDR5P20R2	13	SRW03S-38	31	STP10P3C20	75		
SDR10P3RK4	14	SDR5P230N2	12	SRW03S-38Q	31	STP10P3C32	75		
SDR10P40N2	13	SDR5P24R2	13	SRW07-38	31	STP10S12B12	75		
SDR10P40N3	13	SDR5P26N2	12	SRW07-50	31	STP10S3B12	75		
SDR10P40NK3	13	SDR5P30N2	12	SSD10A10S	29	STP10S5B12	75		



# Mission

*To create and serve customers with quality products and service that meet or exceed their expectations.*

# History

## A History of Success

Sioux Tools has a long and proud heritage of innovation as they have helped to shape the face of the tool industry. The company was started in November of 1914 by Swedish tool maker, Oscar Albertson, and office boy, Harold Jacobson, with a goal to become the “best machine and tool shop”. Sioux has since grown to become a trusted partner by a wide range of industrial and manufacturing segments.

Originally named Albertson & Company, the first items manufactured were piston rings, spark plugs and a gas saver. They soon expanded their line to become a powerful force in the marketplace. In early 1917, Oscar Albertson designed a valve lathe – a hand tool used to seat engine valves. This invention proved to be the foundation upon which Sioux Tools has built a reputation for innovation throughout the world.

During the 1920s the company revolutionized the tool industry by introducing some of the very first hand held power tools. In 1958 the company further solidified its position as a market leader by designing and producing its first air powered tools. Today, Sioux Tools has been granted well over 100 patents. Innovation, ingenuity and insight have established Sioux tools in the minds of the professional as the tool to depend on. Our commitment to continued development in ergonomics and innovative design ensures that we will meet the needs of professionals for many years to come.

Wherever there are markets for quality-built, reliable products, backed by strong after-sale dedication to customer satisfaction, you'll find Sioux Tools. Today we continue to strive to live up to our founding father's wish of being the “best in the world”.

In 1994 Sioux Tools joined Snap-on Incorporated, which added industrial power tools to the extensive Snap-on line. Snap-on Incorporated is a leading global developer, manufacturer and marketer of tool and equipment solutions for professional tool users. Product lines include hand and power tools, diagnostics and shop equipment, tool storage products, diagnostics software and other solutions for the transportation service, industrial, government, education, agricultural, and other commercial applications, including construction and electrical. Founded in 1920, Snap-on is a \$3+ billion, S&P 500 company headquartered in Kenosha, Wisconsin and employs approximately 14,000 worldwide.

# Committed

## Committed to your Success

For over 100 years, Sioux Tools has been providing tools that have been designed and built by the best engineers in the country. We use only top-quality materials in our manufacturing process, and we offer the strongest support and warranty in the business. Our over 100 patents are an indication of our innovation in product development and design.

Sioux Tools are built tough to provide you with many years of trouble-free service. But as with any piece of equipment, service problems can occur, thus Sioux tools are designed to make servicing quick, easy and affordable.

To help ensure fast repairs, which in turn limit downtime, Sioux Tools offers training seminars that cover all the details of the tools we make. For information on our training program, please contact your local Sioux Tools representative.

# ISO/Warranty

## Sioux Tool Power Tools Warranty

**SIoux TOOLS WARRANTS TO THE ORIGINAL PURCHASER THAT THE COMPANY'S POWER TOOLS ARE FREE FROM DEFECTS IN MATERIALS AND WORKMANSHIP.** For one (1) year following the date of purchase, Sioux Tools will repair or replace, at Sioux Tools' option, any part that is defective in materials or workmanship. All warranty requests or claims must be made no later than 60 days following the end of the 1-year warranty period. Repair or replacement shall be at the election and expense of Sioux Tools, and is the exclusive remedy in place of all other rights and remedies.





## SIOUX TOOLS INDUSTRIAL CATALOG

**NO OTHER WARRANTIES, EXPRESS, IMPLIED OR STATUTORY, INCLUDING WITHOUT LIMITATION ANY IMPLIED WARRANTY OF MERCHANTABILITY OR FITNESS FOR A PARTICULAR PURPOSE, SHALL APPLY AND ALL SUCH WARRANTIES ARE HEREBY EXPRESSLY DISCLAIMED.** Sioux Tools' warranty applies only to new products purchased from Sioux Tools or its authorized distributors. Sioux Tools does NOT provide warranty for products subjected to abnormal use. Abnormal use includes: misuse, accident, modification, unreasonable use, neglect, lack of maintenance, or use after the tool is significantly worn or repaired by someone other than Sioux Tools or its Authorized Service Representatives.

A consumable product or part is warranted at the time of sale, only against defects in workmanship and materials that prevent its use. Consumable items are goods reasonably expected to be used up or damaged during use, including but not limited to drill bits, saw blades, grinding discs, sanding discs, batteries, and light bulbs.

**SIOUX TOOLS SHALL NOT BE LIABLE FOR ANY INCIDENTAL, SPECIAL, CONSEQUENTIAL COSTS OR DAMAGES INCURRED BY THE PURCHASER OR OTHERS** (including, without limitation, lost profits, revenues, anticipated sales, business opportunities or goodwill, interruption of business and any other injury or damage.)

This warranty is non-transferable. Sioux Tools reserves the right to make changes in design and/or construction at any time without incurring any obligation related to tools previously sold.

### ISO 9001

In 1997 Sioux Tools received its ISO 9001 certification. This certification is essential to doing business in today's global marketplace. It affirms our dedication to quality and our continued commitment to improvement. It assures our customers that the products they purchase will consistently live up to the promise of performance. It also validates our target goal of achieving maximum quality in every stage of the process - from the initial concept and development all the way through the delivery of spare parts. Our customers can be certain that Sioux tools will live up to their high expectations and provide a long, trouble-free life.



# Industrial Tools

Sioux Tools is known around the world for quality, durability and performance. Our extensive and always expanding line of industrial power tools are engineered to make any job easier, safer and more efficient. We build tools that stand up to the demanding specifications required by today's industrial manufacturing, assembly and finishing needs. Our industrial line of tools is second to none in power, workmanship and total quality.

### We Design Tools To Fit The Application

Sioux has been an innovator in designing tools that fill unique applications. The exclusive Z-handle design enables manufacturers to have a tool that will fit into extremely tight spaces yet maintain the full industrial power.

### Research & Development

As new manufacturing techniques develop they bring with them new demands that may not be met with conventional air tools. Sioux Tools is ready to meet these needs by utilizing our engineering technology coupled with the latest innovations and technological advancements in the power tool industry.

We research the need to develop a new tool and then our Sioux team of engineers and designers go to work to produce the most efficient and versatile tool possible. We are constantly working to increase our product offering, but those new products must live up to our high expectations. Our extensive design engineering, research and development experience has proven our ability and commitment to build quality tools.

### Continuous Quality Control

Every Sioux product undergoes rigorous performance tests at precise stages from design conception through product assembly and packaging to ensure they meet our own high standards and the demands of our customers. Only the finest materials are used in production, and no tool leaves our plant without thorough testing to meet Sioux quality standards. We've built our reputation on producing top-of-the-line industrial tools.



# The Signature Series

Inspired by the operator, designed by Sioux Tools. Since 1914, Sioux Tools has been committed to bringing productive solutions to the pneumatic power tool industry.

Signature Series is an innovative pneumatic power tool program created through the implementation of next generation ergonomics, productivity enhanced features, value and accuracy.

Through industry research and operator input, we have engineered a program that truly delivers tools for the way you work!



## Catalog Guide

### Color-coded Tabs

Quick reference indicator to locate a particular section

### Product Description

Instant reference to the type of tools displayed

### Performance

Range of principle performance characteristics

### Features

List of significant features common to all items

### Specification Chart

Comparison chart of all models in this category including performance specifications and characteristics

### General Info

Specifications that are common to all tools on the page

### Standard Equipment

Listing of items that are included with purchase

### Accessories

Shows what accessories are available or where to locate them in the catalog

### Photos

Visual reference of selective models

ASSEMBLY | SIoux TOOLS INDUSTRIAL CATALOG  
RIGHT ANGLE NUTRUNNERS

**Performance:**  
Torque: 20 in lb (2.3 Nm) – 600 in lb (68 Nm)  
Speed: 300 rpm – 2000 rpm

**Features:**  
Reversible  
Lever Start  
Rear and Side Exhaust

**Right Angle Nutrunners**

Model Number	Bolt Capacity		Max Torque (Soft Joint)		Free Speed rpm	Weight		Length		Side To Center		Drive Size	
	In	mm	In lb	Nm		Lb	Kg	In	mm	In	mm	In	mm
<b>Torque Control Clutch</b>													
3A2104 <sup>1</sup>	3/8	M10	360	41	300	7.4	3.45	19.5	465	0.8	20	1/2	13
3A209 <sup>1</sup>	3/8	M10	294	33	400	7.8	3.40	19.3	465	0.8	20	1/2	13
<b>Adjustable Clutch</b>													
1AM2106	#10	M4.5	50	5.7	800	1.9	0.90	11.6	295	0.3	8	1/4	6
<b>Ball Drive</b>													
1AM2102	#10	M4.5	50	5.7	800	1.5	0.70	11.5	292	0.3	8	1/4	6
<b>Ball Drive</b>													
3A2102 <sup>1</sup>	7/16	M11	600	68	300	6.2	2.81	17.6	459	0.8	20	1/2	13
3A2104 <sup>1</sup>	7/16	M11	600	68	300	5.5	2.50	15.5	394	0.8	20	1/2	13
<b>Soft Drive</b>													
SNR10A35	3/8	M10	400	45.2	300	2.9	1.30	12	305	0.8	20	3/8	10
SNR10A55	3/8	M10	325	36.7	500	2.9	1.30	12	305	0.8	20	3/8	10
SNR10A65	3/8	M10	225	24.9	600	2.9	1.30	12	305	0.8	20	3/8	10
SNR10A10S	7/16	M8	146	16.4	1000	2.9	1.30	12	305	0.8	20	3/8	10
SNR10A16S	1/4	M6	80	9.0	1600	2.6	1.15	11	280	0.8	20	3/8	10
SNR10A25S	#10	M4.5	58	6.6	2000	2.6	1.15	11	280	0.8	20	1/4	6

<sup>1</sup> NIE CE Certified  
<sup>2</sup> Both capacities are based on suggested assembly torques applied to SAE (Grade 5 and metric Class 9.8) fasteners under slightly lubricated conditions.  
**General:**  
 Air Inlet Size: 1/4" NPT • Recommended Hose Size: 1/4" (6 mm) (1AM series), 3/8" (10 mm) (SNR, 3A series) • Performance rated @ 90 psig (6.2 bar) air pressure  
**Standard Equipment:**  
 Parts List • Safety and Instruction Manual • Control Grip (1AM series) • Clutch Adjustment Wrench  
**Accessories:**  
 Nutrunner Accessories, see page 36

**WARNING** SAFETY PRECAUTION: Read and follow all safety and operating instructions. WARNING: Face & eye protection must be worn while operating power tools, per ANSI B166.1

### Safety Info

A brief reminder of safety when operating industrial power tools

# Catalog Guide

## Standard Equipment

Under this heading a specification is given for each type of tool and of the parts (nipples, keys, guards, etc.) supplied with the tool.

A parts list and safety and instruction manual are always included in the package with every tool.

## Air Consumption

The air consumption of the tools is stated in cubic feet per minute (cfm) and liters per second, l/s, and relates to free air, i.e., the compressed air expanded to atmospheric pressure. Unless otherwise stated, the figures are valid at a working pressure of 90 psig (6.2 bar) and indicate the maximum air consumption unless otherwise stated.

Maximum air consumption for non-governed tools is achieved at free speed when the tool is running at no load. A tool with governed speed control has the maximum air consumption at the maximum power output.

## Speed

The tool speeds are indicated in revolutions per minute, (rpm), and indicate the free speed, i.e., the speed at which the tool runs at no load and at a working pressure of 90 psig (6.2 bar), unless otherwise specified. The speed at maximum output is estimated as 50% of the idling speed for non-governed tools and 80-90% of the idling speed for tools with governed speed control.

## Quick Conversion Chart

### Length:

1 in	=	0.0254 m
1 m	=	39.3701 in
1 m	=	3.2808 ft
1 in	=	25.4 mm
1 ft	=	304.8 mm
1 mm	=	0.03937 in

### Weight:

1 lb	=	0.4536 kg
1 kg	=	2.2046 lb

### Torque:

1 kpm	=	9.8067 Nm
1 ft lb	=	1.3558 Nm
1 in lb	=	0.1130 Nm
1 Nm	=	0.1020 kpm
1 Nm	=	0.7376 ft lb

## Model Number

Many tools have very similar performance characteristics. These subtle differences are often indicated by the addition of letters after the model number.

## Weight and Length

The weight of the tools is listed in both pounds (lb) and kilograms (kg), and the length is listed in both inches (in) and millimeters (mm).

## Side to Center

This measurement is taken from the center of the tool to the outside edge. It is useful for applications requiring the tool to fit into a precise or limited space.

## Sound Level

In the field of ergonomics, sound level is very important to the safety and well-being of the operator. Sound levels are listed, where applicable, in decibels dB(A).

### Pressure:

1 bar	=	100 kPa
1 kg/cm <sup>2</sup> (at)	=	98.0665 kPa
1 psi	=	6.8948 kPa
1 kPa	=	0.145 psi
1 kPa	=	0.01 bar
1 kPa	=	0.0101972 kg/cm <sup>2</sup> (at)

### Power:

1 kgm/s	=	9.8067 w
1 hp	=	745.7 w
1 kw	=	101.972 kgm/s
1 kw	=	1.3410 hp

### Flow:

1 m <sup>3</sup> /min	=	16.6667 l/s
1 cfm	=	0.4720 l/s
1 m <sup>3</sup> /h	=	0.2778 l/s
1 l/s	=	2.1189 cfm





# DRILLS

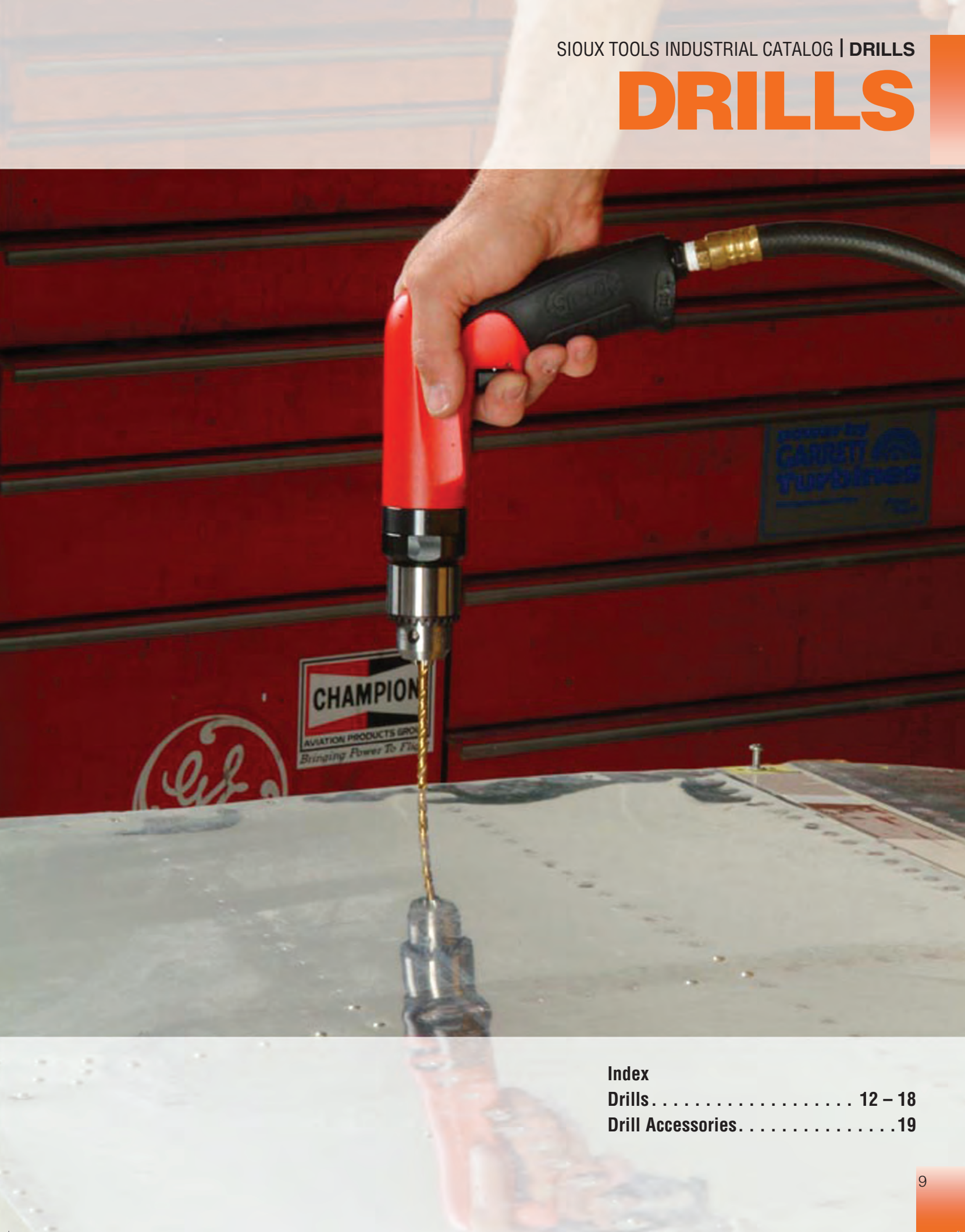

Index	
Drills . . . . .	12 – 18
Drill Accessories . . . . .	19

# DRILLS

Performance, Serviceability, Ergonomics and Value...



Light weight aluminum housing



Ergonomic, handle with soft textured grip



Available in 1 hp and .6 hp motor



3 planet gear system for increased life and load capacity



Teasing throttle, conveniently located reverse

## Industry Leader

Regarded as the Number 1 choice in the industry, Sioux Tools' pneumatic drills are known around the world for their exceptional engineering and construction. A wide range of configurations, speeds, and options ensure a perfect match for any application. Through next generation ergonomics and the continued focus on productivity and operator safety comes the development of the Sioux Tools Signature Series Drill line.

Signature Series Drills are used in applications ranging from manufactured housing and wood working to light assembly. With free speeds from 300 to 16,000 rpm we have the right drill for any application, for use with any type of material. The powerful five vane motor makes these drills great for drilling applications that contain ferrous and non-ferrous metals, wood and composite materials. The Signature Series Drills offer great value with a 3 planet gear system for increased life and load capacity. The Sioux tools Signature Series Drill line reduces operator fatigue by offering a low sound level and low vibration solution! Operator comfort is achieved through the implementation of a light weight aluminum housing and a comfort grip. Drills are available in both reverse and non-reverse models and are available in pistol grip, straight, Z-handle and D and T-handles, and offer a variety of chuck and collet size.

## Innovative Design

Our exclusive Z-handle models are often the only drills that will get you into those tough, hard to reach spaces, and our miniature aircraft angle drills are designed with small, compact 45° and 90° heads and internal threaded spindles that accept a variety of aircraft precision drill bits.

## 360° Rotation

The SDR10S40N360 has a unique 360° rotating head for applications in hard to reach places or difficult angles.

## T-Handles

Our exceptional T-handle drills help reduce stress on the operators back and arms while making short work of any decking application.

## Ergonomics

All Sioux Drills offer ergonomic features to provide maximum comfort during operation. Many models include comfortable insulating grips to reduce cold and vibration. We also offer optional support handles for most models.

## Drill Maintenance

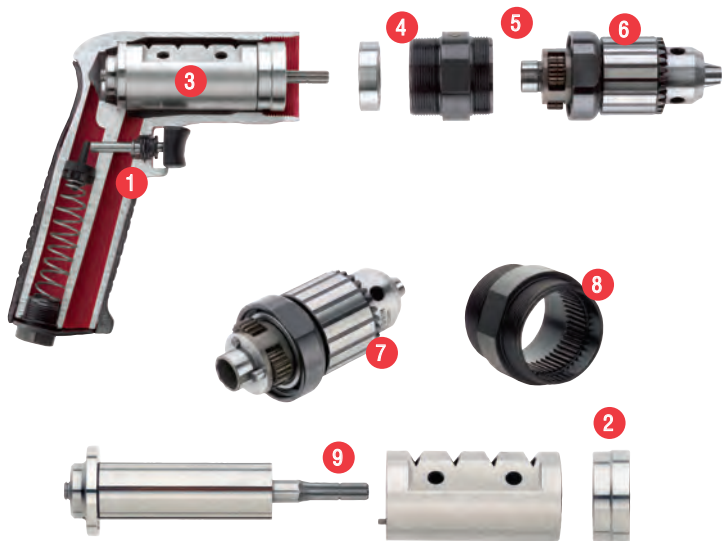

- 1 Tipper valve and valve seat is easily accessible for service
- 2 Slip fit of front end plate bearing allows easy service of the air motor without disturbing the rotor spacing
- 3 Drop in motor. No alignment necessary (applies to non-reversing drills only)
- 4 Rotor pinion is case hardened to resist wear
- 5 Grease zerk makes it easy to grease the gears without disassembly
- 6 Planetary reduction can be serviced without removing the chuck
- 7 Planet gear pins are slip fit for ease of assembly and disassembly
- 8 Ring gear is machined into the motor retainer for ease of assembly and disassembly
- 9 Interchangeable rotor, cylinder, bearings and end plates. This reduces the number of spare parts tool cribs need to stock



## Accessories

Sioux carries an extensive selection of drill accessories, including hole saws and wire brushes.

See the drill accessory section in this catalog for a comprehensive listing.

## Drill Safety

### Chips can cause eye injury.

Drilling creates chips. Proper eye protection must be worn at all times by tool user and bystanders.

### Broken drill bits can cause eye injury.

Proper eye protection must be worn at all times by tool user and bystanders.

### Sudden and unexpected tool movement can cause injury.

Be sure your body position allows you to have control of the tool at all times. Make sure your footing is secure.

### Tools starting unexpectedly can cause injury.

Always remove tool from air supply and activate trigger to bleed air line before making any adjustments, changing accessories, or doing any maintenance or service on the tool.

## Drill Principles of Operation

An air motor and reduction gearing are used to drive a spindle / drill chuck, which holds accessories for drilling, reaming, tapping, and hole sawing. Motor size (horsepower), gear ratio, handle style and drive spindle determine the type of tool needed to handle an application.

## Drill Uses

Pneumatic drills may first be thought of for drilling holes in wood, metal, or plastic. Drills are used in a wide variety of applications. Each of these applications require the proper tool with the proper horsepower and speed to get the best results. Drilling – cutting a hole in material using a fluted bit. Reaming – opening up or sizing a previously drilled hole or aligning offset holes. Tapping – cutting threads in a drilled hole to accept threaded fasteners.

## Where Used

- Continuous-duty production drilling
- For initial tap operations and thread chasing
- Wire brushing and deburring
- Screwdriving
- Hole sawing
- General Maintenance

## Considerations for Selecting Drills

- What type of material is being drilled?
- What size of hole will need to be drilled?
- What are your horsepower requirements?
- What speed requirements do you have?

### Drill Speed Guide

## Drill Speed Guide

Material	Surface Ft/Min	Size of Hole to be Drilled							
		1/16 in 1.5 mm	1/8 in 3.0 mm	3/16 in 5.0	1/4 in 6.0 mm	5/16 in 8.0 mm	3/8 in 9.5 mm	7/16 in 11.0 mm	1/2 in 13.0 mm
Recommended Cutting Speed Range (rpm)									
Steel Alloy, 300-400 Brinnel	20-30	1250-1800	600-900	400-600	300-450	250-350	200-300	175-250	150-225
Stainless Steel, Cast Iron, Hard	30-40	1800-2500	900-1200	600-800	450-600	350-500	300-400	250-350	225-300
Steel Forgings	40-50	2500-3100	1200-1500	800-1000	600-750	500-600	400-500	350-425	300-400
Steel, Tool Annealed, .90-1.20 Carbon	50-60	3100-3700	1500-1800	100-1200	750-900	600-700	500-600	425-525	400-450
Steel, .40-.50 Carbon	70-80	4300-5000	2100-2500	1400-1600	1000-1200	850-1000	700-800	600-700	500-600
Cast Iron, Medium Hard	70-100	4300-6000	2100-3000	1400-2000	1000-1500	850-1200	700-1000	600-900	500-800
Bronze, High Tensile Strength	70-150	4300-9000	2100-4500	1400-3000	1000-2300	850-1200	700-1530	600-1300	500-1200
Malleable Iron	80-90	5000-5500	2500-2800	1600-1800	1200-1400	950-1100	800-900	700-800	600-700
Steel, Mild .20-.30 Carbon	80-110	5000-6700	2500-3400	1600-2300	1200-1700	950-1350	800-1150	700-1000	600-850
Cast Iron, Soft Plastic	100-150	6000-9000	3000-4500	2000-3000	1500-2300	1200-1800	1000-1530	900-1300	800-1200
Aluminum, Brass, Bronze	200-300	12,000-18,000	6000-9000	4000-6000	3000-4500	2400-3700	2000-3000	1700-2600	1500-2300
Magnesium	250-400	15,500-25,000	7500-12,000	5000-8200	3800-6100	3000-4900	2500-4000	2200-3500	1900-3000
Fiberglass, Wood	300-400	18,000-25,000	9000-12,000	6000-8200	4600-6100	3700-4900	3000-4000	2600-3500	2300-3000

Actual drilling or cutting RPM will be approximately 70% of rated spindle speed of tool. Surface Feet Per Minute = .26 x RPM x Drill Diameter in Inches.

PISTOL GRIP DRILLS



**Performance:**

Power: 0.4 hp (0.30 kW) – 1 hp (0.75 kW)  
 Speed Range: 300 rpm – 23,000 rpm  
 Chuck Capacity: 1/4" (6 mm) – 1/2" (13 mm)

**Features:**

Rubber Grip

**Non-Reversible**

Model Number	Chuck Capacity		Free Speed rpm	Weight		Length		Side To Center		Maximum Air Consumption		Spindle Thread
	in	mm		lb	kg	in	mm	in	mm	cfm	l/s	
<b>0.4 hp (0.30 kW) – Keyed Chuck</b>												
SDR4P5N2	1/4	6	500	1.7	0.8	6.1	155	0.7	17	20	10	3/8"-24
SDR4P8N2	1/4	6	800	1.7	0.8	6.1	155	0.7	17	20	10	3/8"-24
SDR4P12N2	1/4	6	1200	1.7	0.8	6.1	155	0.7	17	20	10	3/8"-24
SDR4P26N2	1/4	6	2600	1.6	0.7	5.5	140	0.7	16.8	20	10	3/8"-24
SDR4P30N2	1/4	6	3000	1.6	0.7	5.5	140	0.7	16.8	20	10	3/8"-24
SDR4P36N2	1/4	6	3600	1.6	0.7	5.5	140	0.7	16.8	20	10	3/8"-24
SDR4P43N2	1/4	6	4300	1.6	0.7	5.5	140	0.7	16.8	20	10	3/8"-24
SDR4P50N2	1/4	6	5000	1.6	0.7	5.5	140	0.7	16.8	20	10	3/8"-24
<b>0.5 hp (0.37 kW) – Keyed Chuck</b>												
SDR5P5N2	1/4	6	500	1.7	0.8	6.1	155	0.7	16.8	30	14	3/8"-24
SDR5P7N2	1/4	6	700	1.7	0.8	6.1	155	0.7	16.8	30	14	3/8"-24
SDR5P8N2	1/4	6	800	1.7	0.8	6.1	155	0.7	16.8	30	14	3/8"-24
SDR5P12N2	1/4	6	1200	1.7	0.8	6.1	155	0.7	16.8	30	14	3/8"-24
SDR5P26N2	1/4	6	2600	1.5	0.7	5.5	140	0.7	16.8	30	14	3/8"-24
SDR5P30N2	1/4	6	3000	1.5	0.7	5.5	140	0.7	16.8	30	14	3/8"-24
SDR5P36N2	1/4	6	3600	1.5	0.7	5.5	140	0.7	16.8	30	14	3/8"-24
SDR5P43N2	1/4	6	4300	1.5	0.7	5.5	140	0.7	16.8	30	14	3/8"-24
SDR5P50N2	1/4	6	5000	1.5	0.7	5.5	140	0.7	16.8	30	14	3/8"-24
SDR5P230N2	1/4	6	23000	1.3	0.6	4.8	120	0.7	16.8	30	14	3/8"-24
<b>0.60 hp (0.45 kW) – Keyed Chuck</b>												
SDR6P3N2	1/4	6	300	2.1	0.95	6.8	171	0.8	20	25	12	3/8"-24
SDR6P4N3	3/8	10	400	2.7	1.20	7.3	185	0.8	20	25	12	1/2"-20
SDR6P4N4	1/2	13	400	3.1	1.40	7.8	200	0.8	20	25	12	1/2"-20
SDR6P7N3	3/8	10	700	2.7	1.20	7.3	185	0.8	20	25	12	1/2"-20
SDR6P7N4	1/2	13	700	3.1	1.40	7.8	200	0.8	20	25	12	1/2"-20
SDR6P12N3	3/8	10	1200	2.7	1.20	7.3	185	0.8	20	25	12	1/2"-20
SDR6P26N2	1/4	6	2600	2.1	0.95	5.8	145	0.8	20	25	12	3/8"-24
SDR6P26N3	3/8	10	2600	2.3	1.00	6.3	160	0.8	20	25	12	3/8"-24
SDR6P26N4	1/2	13	2600	2.7	1.20	6.6	170	0.8	20	25	12	1/2"-20
SDR6P40N2	1/4	6	4000	2.1	0.95	5.8	145	0.8	20	25	12	3/8"-24
SDR6P40N3	3/8	10	4000	2.3	1.00	6.3	160	0.8	20	25	12	3/8"-24
SDR6P60N2	1/4	6	6000	2.1	0.95	5.8	145	0.8	20	25	12	3/8"-24
SDR6P60N3	3/8	10	6000	2.3	1.00	6.3	160	0.8	20	25	12	3/8"-24
<b>0.60 hp (0.45 kW) – Keyless Chuck</b>												
SDR6P7NK3	3/8	10	700	2.7	1.20	7.3	185	0.8	20	25	12	3/8"-24
SDR6P26NK3	3/8	10	2600	2.3	1.00	6.3	160	0.8	20	25	12	3/8"-24
SDR6P40NK3	3/8	10	4000	2.3	1.00	6.3	160	0.8	20	25	12	3/8"-24
SDR6P60NK3	3/8	10	6000	2.3	1.00	6.3	160	0.8	20	25	12	3/8"-24
<b>1 hp (0.75 kW) – Keyed Chuck</b>												
SDR10P4N3	3/8	10	400	2.9	1.30	8.0	205	0.8	20	30	14	1/2"-20
SDR10P4N4	1/2	13	400	3.3	1.50	8.5	215	0.8	20	30	14	1/2"-20
SDR10P7N3	3/8	10	700	2.9	1.30	8.0	205	0.8	20	30	14	1/2"-20
SDR10P7N4	1/2	13	700	3.3	1.50	8.5	215	0.8	20	30	14	1/2"-20
SDR10P12N3	3/8	10	1200	2.9	1.30	8.0	205	0.8	20	30	14	1/2"-20
SDR10P12N4	1/2	13	1200	3.3	1.50	8.5	215	0.8	20	30	1/4	1/2"-20
SDR10P16N3	3/8	10	1600	2.9	1.30	8.0	205	0.8	20	30	14	1/2"-20
SDR10P16N4	1/2	13	1600	3.3	1.50	8.5	215	0.8	20	30	1/4	1/2"-20
SDR10P26N2	1/4	6	2600	2.3	1.05	6.5	165	0.8	20	30	14	3/8"-24



**SAFETY PRECAUTION:** Read and follow all safety and operating instructions.  
**WARNING:** Face & eye protection must be worn while operating power tools, per ANSI B186.1



SDR10P26N3	3/8	10	2600	2.5	1.10	7.0	180	0.8	20	30	14	3/8"-24
SDR10P26N4	1/2	13	2600	2.9	1.30	7.5	190	0.8	20	30	14	1/2"-20
SDR10P40N2	1/4	6	4000	2.3	1.05	6.5	165	0.8	20	30	14	3/8"-24
SDR10P40N3	3/8	10	4000	2.5	1.10	7.0	180	0.8	20	30	14	3/8"-24
SDR10P60N2	1/4	6	6000	2.3	1.05	6.5	165	0.8	20	30	14	3/8"-24
SDR10P60N3	3/8	10	6000	2.5	1.10	7.0	180	0.8	20	30	14	3/8"-24
SDR10P180N2	1/4	6	18000	1.85	0.84	5.5	140	0.8	20	30	14	3/8"-24
SDR10P210N2	1/4	6	21000	1.85	0.84	5.5	140	0.8	20	30	14	3/8"-24
<b>1 hp (0.75 kW) – Keyless Chuck</b>												
SDR10P4NK4	1/2	13	400	3.1	1.40	7.8	200	0.8	20	30	14	1/2"-20
SDR10P7NK4	1/2	13	700	3.1	1.40	7.8	200	0.8	20	30	14	1/2"-20
SDR10P12NK3	3/8	10	1200	2.7	1.20	7.3	185	0.8	20	30	14	3/8"-24
SDR10P26NK3	3/8	10	2600	2.3	1.00	6.3	160	0.8	20	30	14	3/8"-24
SDR10P26NK4	1/2	13	2600	2.7	1.20	6.6	170	0.8	20	30	14	1/2"-20
SDR10P26NL4	1/2	13	2600	2.7	1.20	6.7	171	0.8	20	30	14	1/2"-20
SDR10P40NK3	3/8	10	4000	2.3	1.05	8.3	210	0.8	19	30	14	3/8"-24
SDR10P60NK3	3/8	10	6000	2.5	1.10	7.0	180	0.8	20	30	14	3/8"-24
<b>1 hp (0.75 kW) – Keyed Chuck</b>												
3P1140 <sup>1</sup>	1/2	13	360	5.0	2.30	8.8	224	1.03	26	33	15	1/2"-20
3P1240 <sup>1</sup>	1/2	13	650	5.0	2.30	8.8	224	1.03	26	33	15	1/2"-20
3P1340 <sup>1</sup>	1/2	13	1000	5.0	2.30	8.8	224	1.03	26	33	15	1/2"-20
3P1430 <sup>1</sup>	3/8	10	1400	5.0	2.30	8.8	224	1.03	26	33	15	1/2"-20
3P1530 <sup>1</sup>	3/8	10	2150	4.3	2.00	7.5	190	1.03	26	33	15	1/2"-20
3P1540 <sup>1</sup>	1/2	13	2150	4.3	2.00	7.5	190	1.03	26	33	15	1/2"-20
3P1640 <sup>1</sup>	1/2	13	2650	4.3	2.00	7.5	190	1.03	26	33	15	1/2"-20

<sup>1</sup> Not CE Compliant

**General:** Air Inlet Size: 1/4" NPT • Recommended Hose Size: 3/8" (10 mm) • Performance rated @ 90 psig (6.2 bar) air pressure

**Standard Equipment:** Parts List • Safety and Instruction Manual • 3-jaw Chuck and Key • Comfort Grip

**Accessories:** Drill Accessories, see page 19



**PISTOL GRIP DRILLS**

**Performance:**

Power: 0.4 hp (0.30 kW) – 1 hp (0.75 kW)  
 Speed Range: 300 rpm – 4,000 rpm  
 Chuck Capacity: 1/4" (6 mm) – 1/2" (13 mm)

**Features:**

Rubber Grip

**Reversible**

Model Number	Chuck Capacity		Free Speed rpm	Weight		Length		Side To Center		Maximum Air Consumption		Spindle Thread
	in	mm		lb	kg	in	mm	in	mm	cfm	l/s	
<b>0.4 hp (0.30 kW) – Keyed Chuck</b>												
SDR4P3R2	1/4	6	300	1.8	0.8	6.4	165	0.7	17	20	10	3/8"-24
SDR4P5R2	1/4	6	500	1.8	0.8	6.4	165	0.7	17	20	10	3/8"-24
SDR4P8R2	1/4	6	800	1.8	0.8	6.4	165	0.7	17	20	10	3/8"-24
SDR4P18R2	1/4	6	1800	1.6	0.7	5.8	150	0.7	16.8	20	10	3/8"-24
SDR4P20R2	1/4	6	2000	1.6	0.7	5.8	150	0.7	16.8	20	10	3/8"-24
SDR4P24R2	1/4	6	2400	1.6	0.7	5.8	150	0.7	16.8	20	10	3/8"-24
SDR4P30R2	1/4	6	3000	1.6	0.7	5.8	150	0.7	16.8	20	10	3/8"-24
SDR4P33R2	1/4	6	3300	1.6	0.7	5.8	150	0.7	16.8	20	10	3/8"-24
<b>0.5 hp (0.37 kW) – Keyed Chuck</b>												
SDR5P3R2	1/4	6	300	1.7	0.8	6.4	165	0.7	16.8	30	14	3/8"-24
SDR5P5R2	1/4	6	500	1.7	0.8	6.4	165	0.7	16.8	30	14	3/8"-24
SDR5P8R2	1/4	6	800	1.7	0.8	6.4	165	0.7	16.8	30	14	3/8"-24
SDR5P18R2	1/4	6	1800	1.5	0.7	5.8	150	0.7	16.8	30	14	3/8"-24
SDR5P20R2	1/4	6	2000	1.5	0.7	5.8	150	0.7	16.8	30	14	3/8"-24
SDR5P24R2	1/4	6	2400	1.5	0.7	5.8	150	0.7	16.8	30	14	3/8"-24
SDR5P30R2	1/4	6	3000	1.5	0.7	5.8	150	0.7	16.8	30	14	3/8"-24
SDR5P33R2	1/4	6	3300	1.5	0.7	5.8	150	0.7	16.8	30	14	3/8"-24



**SAFETY PRECAUTION:** Read and follow all safety and operating instructions.  
**WARNING:** Face & eye protection must be worn while operating power tools, per ANSI B186.1

## 1 hp (0.75 kW) – Keyed Chuck

SDR10P3R3	3/8	10	300	3.1	1.40	8.6	220	0.8	20	30	14	1/2"-20
SDR10P3R4	1/2	13	300	3.6	1.60	9.1	230	0.8	20	30	14	1/2"-20
SDR10P5R3	3/8	10	500	3.1	1.40	8.6	220	0.8	20	30	14	1/2"-20
SDR10P5R4	1/2	13	500	3.6	1.60	9.1	230	0.8	20	30	14	1/2"-20
SDR10P7R3	3/8	10	700	3.1	1.40	8.6	220	0.8	20	30	14	1/2"-20
SDR10P7R4	1/2	13	700	3.6	1.60	9.1	230	0.8	20	30	14	1/2"-20
SDR10P12R3	3/8	10	1200	3.1	1.40	8.6	220	0.8	20	30	14	1/2"-20
SDR10P12R4	1/2	13	1200	3.6	1.60	9.1	230	0.8	20	30	14	1/2"-20
SDR10P20R2	1/4	6	2000	2.4	1.10	7.1	180	0.8	20	30	14	3/8"-24
SDR10P20R3	3/8	10	2000	2.6	1.15	7.6	195	0.8	20	30	14	3/8"-24
SDR10P20R4	1/2	13	2000	3.0	1.35	7.9	200	0.8	20	30	14	1/2"-20
SDR10P25R3	3/8	10	2500	2.6	1.15	7.6	195	0.8	20	30	14	3/8"-24
SDR10P40R2	1/4	6	4000	2.4	1.10	7.1	180	0.8	20	30	14	3/8"-24
SDR10P40R3	3/8	10	4000	2.6	1.15	7.6	195	0.8	20	30	14	3/8"-24

## 1 hp (0.75 kW) – Keyless Chuck

SDR10P3RK4	1/2	13	300	3.6	1.60	9.1	230	0.8	20	30	14	1/2"-20
SDR10P5RK4	1/2	13	500	3.6	1.60	9.1	230	0.8	20	30	14	1/2"-20
SDR10P7RK4	1/2	13	700	3.6	1.60	9.1	241	0.8	20	30	14	1/2"-20
SDR10P12RK4	1/2	13	1200	3.6	1.60	9.1	230	0.8	20	30	14	1/2"-20
SDR10P20RK3	3/8	10	2000	2.6	1.20	7.6	195	0.8	20	30	14	3/8"-24
SDR10P20RK4	1/2	13	2000	3.0	1.35	8.0	205	0.8	20	30	14	1/2"-20
SDR10P25RK3	3/8	10	2500	2.6	1.15	7.6	195	0.8	20	30	14	3/8"-24
SDR10P40RK3	3/8	10	4000	2.6	1.15	7.6	195	0.8	20	30	14	3/8"-24

## 0.80 hp (0.60 kW) – Keyed Chuck

3P2140 <sup>1</sup>	1/2	13	300	5.0	2.30	8.8	224	1-1/32	26	33	15	1/2"-20
DR3P2240 <sup>1</sup>	1/2	13	550	5.0	2.30	8.8	224	1-1/32	26	33	15	1/2"-20
3P2340 <sup>1</sup>	1/2	13	850	5.0	2.30	8.8	224	1-1/32	26	33	15	1/2"-20

<sup>1</sup> Not CE Compliant

**General:** Air Inlet Size: 1/4" NPT • Recommended Hose Size: 3/8" (10 mm) • Performance rated @ 90 psig (6.2 bar) air pressure

**Standard Equipment:** Parts List • Safety and Instruction Manual • 3-jaw Chuck and Key • Comfort Grip

**Accessories:** Drill Accessories, see page 19

## RAPID REVERSE DRILLS

### Performance:

Power: 0.60 hp (0.15 kW) – 1 hp (0.75 kW)

Speed Range: 500 rpm – 2,500 rpm

Chuck Capacity: 3/8" (10 mm) – 1/2" (13 mm)

### Features:

Rubber Grip



### Rapid Reverse

Model Number	Chuck Capacity		Free Speed	Weight		Length		Side To Center		Maximum Air Consumption		Spindle Thread
	in	mm	rpm	lb	kg	in	mm	in	mm	cfm	l/s	
<b>0.60 hp (0.45 kW) – Keyed Chuck</b>												
SDR6P20R3RR	3/8	10	2000	2.3	1.00	6.3	160	0.8	20	25	12	3/8"-24
SDR6P25R3RR	3/8	10	2500	2.3	1.00	6.3	160	0.8	20	25	12	3/8"-24
<b>0.60 hp (0.45 kW) – Keyless Chuck</b>												
SDR6P7RK4RR	1/2	13	700	3.0	1.36	8.8	224	0.8	20	25	12	1/2"-20
SDR6P20RK3RR	3/8	10	2000	2.4	1.25	7.9	200	0.8	20	25	12	3/8"-24
SDR6P20RK4RR	1/2	13	2000	2.7	1.20	8.3	210	0.8	20	25	12	1/2"-20
SDR6P25RK3RR	3/8	10	2500	2.4	1.25	7.9	200	0.8	20	25	12	3/8"-24
SDR6P25RK4RR	1/2	13	2500	2.7	1.20	8.3	210	0.8	20	25	12	1/2"-20
<b>1 hp (0.75 kW) – Keyed Chuck</b>												
SDR10P5R4RR	1/2	13	500	3.6	1.63	8.8	224	0.8	20	30	14	1/2"-20
SDR10P25R4RR	1/2	13	2500	3.0	1.36	7.9	200	0.8	20	30	14	1/2"-20
SDR10P20R3RR	3/8	10	2000	2.6	1.15	7.6	195	0.8	20	30	14	3/8"-24
SDR10P25R3RR	3/8	10	2500	2.6	1.15	7.6	195	0.8	20	30	14	3/8"-24



**SAFETY PRECAUTION:** Read and follow all safety and operating instructions.

**WARNING:** Face & eye protection must be worn while operating power tools, per ANSI B186.1



**1 hp (0.75 kW) – Keyless Chuck**

SDR10P7RK4R	1/2	13	700	3.1	1.40	9.5	241	0.8	20	30	14	1/2"-20
SDR10P20RK3R	3/8	10	2000	2.6	1.15	7.6	195	0.8	20	30	14	3/8"-24
SDR10P20RK4R	1/2	13	2000	2.8	1.27	7.6	195	0.8	20	30	14	1/2"-20
SDR10P25RK3R	3/8	10	2500	2.6	1.15	7.6	195	0.8	20	30	14	3/8"-24
SDR10P25RK4R	1/2	13	2500	2.8	1.27	7.6	195	0.8	20	30	14	1/2"-20

**General:** Air Inlet Size: 1/4" NPT • Recommended Hose Size: 3/8" (10 mm) • Performance rated @ 90 psig (6.2 bar) air pressure

**Standard Equipment:** Parts List • Safety and Instruction Manual • 3-jaw Chuck and Key • Comfort Grip

**Accessories:** Drill Accessories, see page 19

**STRAIGHT DRILLS**



1420



SDR10S26N3



SDR10S25R3

**Performance:**

Power: 0.33 hp (0.25 kW) – 1 hp (0.75 kW)  
 Speed Range: 300 rpm – 21,000 rpm  
 Chuck Capacity: 1/4" (6 mm) – 1/2" (13 mm)

**Features:**

Reversible and Non-Reversible  
 Lever Start  
 Rubber Grip (1420, DR1422)

**Straight Drills**

Model Number	Chuck Capacity		Free Speed rpm	Weight		Length		Side To Center		Maximum Air Consumption		Spindle Thread
	in	mm		lb	kg	in	mm	in	mm	cfm	l/s	
<b>0.33 hp (0.25 kW) – Non-reversible</b>												
1420	1/4	6	2600	1.2	0.54	8.0	203	0.6	15	12	6	3/8"-24
DR1422	1/4	6	3600	1.2	0.54	8.0	203	0.6	15	12	6	3/8"-24
<b>1 hp (0.75 kW) – Non-reversible</b>												
SDR10S4N3	3/8	10	400	2.8	1.25	9.3	236	0.8	20	30	14	1/2"-20
SDR10S4N4	1/2	13	400	2.8	1.25	9.3	236	0.8	20	30	14	1/2"-20
SDR10S7N3	3/8	10	700	2.8	1.25	9.3	236	0.8	20	30	14	1/2"-20
SDR10S12N3	3/8	10	1200	2.8	1.25	9.3	236	0.8	20	30	14	1/2"-20
SDR10S16N3	3/8	10	1600	2.8	1.25	9.3	236	0.8	20	30	14	1/2"-20
SDR10S26N2	1/4	6	2600	2.3	1.05	8.3	211	0.8	20	30	14	3/8"-24
SDR10S26N3	3/8	10	2600	2.3	1.05	8.3	211	0.8	20	30	14	3/8"-24
SDR10S40N2	1/4	6	4000	2.3	1.05	8.3	211	0.8	20	30	14	3/8"-24
SDR10S40N3	3/8	10	4000	2.3	1.05	8.3	211	0.8	20	30	14	3/8"-24
SDR10S60N2	1/4	6	6000	2.3	1.05	8.3	211	0.8	20	30	14	3/8"-24
SDR10S60N3	3/8	10	6000	2.3	1.05	8.3	211	0.8	20	30	14	3/8"-24
SDR10S180N2	1/4	6	18000	1.85	0.84	7.3	185	0.8	20	30	14	3/8"-24
SDR10S210N2	1/4	6	21000	1.85	0.84	7.3	185	0.8	20	30	14	3/8"-24
<b>1 hp (0.75 kW) – Reversible</b>												
SDR10S3R3	3/8	10	300	2.8	1.25	10.8	273	0.8	20	30	14	1/2"-20
SDR10S3R4	1/2	13	300	3.2	1.45	11.3	285	0.8	20	30	14	1/2"-20
SDR10S5R3	3/8	10	500	2.8	1.25	10.8	273	0.8	20	30	14	1/2"-20
SDR10S5R4	1/2	13	500	3.2	1.45	11.3	285	0.8	20	30	14	1/2"-20
SDR10S7R3	3/8	10	700	2.8	1.25	10.8	273	0.8	20	30	14	1/2"-20
SDR10S7R4	1/2	13	700	3.2	1.45	11.3	285	0.8	20	30	14	1/2"-20
SDR10S12R3	3/8	10	1200	2.8	1.25	10.8	273	0.8	20	30	14	1/2"-20
SDR10S12R4	1/2	13	1200	3.2	1.45	11.3	285	0.8	20	30	14	1/2"-20
SDR10S20R2	1/4	6	2000	2.2	1.00	9.3	235	0.8	20	30	14	3/8"-24
SDR10S20R3	3/8	10	2000	2.3	1.05	9.8	248	0.8	20	30	14	3/8"-24
SDR10S20R4	1/2	10	2000	2.8	1.25	10.3	260	0.8	20	30	14	1/2"-20
SDR10S25R2	1/4	6	2500	2.2	1.00	9.3	235	0.8	20	30	14	3/8"-24
SDR10S25R3	3/8	10	2500	2.3	1.05	9.8	248	0.8	20	30	14	3/8"-24
SDR10S40R2	1/4	6	4000	2.2	1.00	9.3	235	0.8	20	30	14	3/8"-24
SDR10S40R3	3/8	10	4000	2.3	1.05	9.8	243	0.8	20	30	14	3/8"-24

**General:**

Air Inlet Size: 1/4" NPT • Recommended Hose Size: 3/8" • Performance rated @ 90 psig (6.2 bar) air pressure

**Standard Equipment:**

Parts List • Safety and Instruction Manual • Suspension Bail • 3-jaw Chuck and Key • Comfort Grip

**Accessories:**

Drill Accessories, see page 19



**SAFETY PRECAUTION:** Read and follow all safety and operating instructions.  
**WARNING:** Face & eye protection must be worn while operating power tools, per ANSI B186.1



MINIATURE ANGLE DRILLS

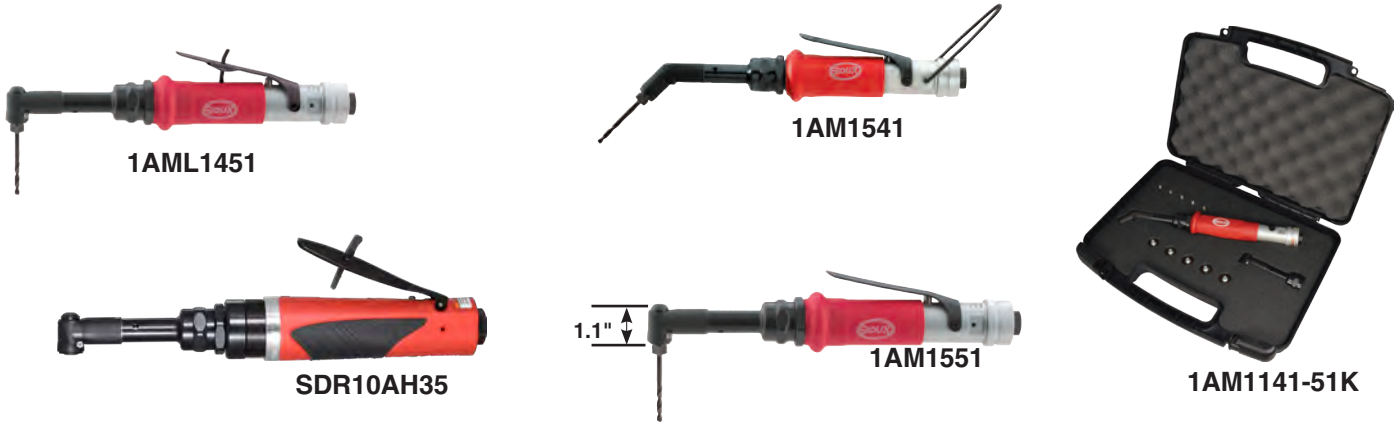

**Performance:**

Power: 0.33 hp (0.25 kW) – 1 hp (0.75 kW)  
 Speed Range: 800 rpm – 3,500 rpm

**Features:**

Non-Reversible  
 Lever Start  
 45° or 90° Miniature Angle Heads (except SDR10S40N360)  
 180° Adjustable Rotating Head (SDR10S40N360)



**Miniature Angle Drills**

Model Number	Free Speed		Weight		Length		Side To Center		Maximum Air Consumption	
	rpm		lb	kg	in	mm	in	mm	cfm	l/s
<b>45° Angle Head – 0.33 hp (0.25 kW) – 1/4"-28 Internal Thread Spindle</b>										
1AM1441	2200		1.5	0.7	10.2	259	0.3	8	12	6
1AM1541	2800		1.5	0.7	10.2	259	0.3	8	12	6
1AML1541 (with Lever Lock)	2800		1.5	0.7	10.2	259	0.3	8	12	6
<b>90° Angle Head – 0.33 hp (0.25 kW) – 1/4"-28 Internal Thread Spindle</b>										
1AM1151	800		1.8	0.80	11.5	292	0.3	8	12	6
1AM1451	2200		1.5	0.7	9.7	246	0.3	8	12	6
1AML1451 (with Lever Lock)	2200		1.5	0.7	9.7	246	0.3	8	12	6
1AM1551	2800		1.5	0.7	9.7	246	0.3	8	12	6
1AML1551 (with Lever Lock)	2800		1.5	0.7	9.7	246	0.3	8	12	6
<b>90° Angle Head – 0.33 hp (0.25 kW) – 9/32"-40 Internal Thread Spindle</b>										
1AM1452	2200		1.5	0.7	9.7	246	0.3	8	12	6
1AM1552	2800		1.5	0.7	9.7	246	0.3	8	12	6
<b>Sealant Removal Tool Kit</b>										
1AM1141/51K	800		1.8	0.80	11.5	292	0.3	8	12	6
Includes 1AM1151 (90° Angle Drill) and 65213 (45° Angle Drill Head Assembly)										
1AM1141SRK	800		1.8	0.80	11.5	292	0.3	8	12	6
Includes 1AM1141 (45° Angle Drill)										
1AM1151SRK	800		1.8	0.80	11.5	292	0.3	8	12	6
Includes 1AM1151 (90° Angle Drill)										
<b>90° Angle Head – 1 hp (0.75 kW) – 1/4"-28 Internal Thread Spindle</b>										
SDR10AH35	3500		2.4	1.09	11.4	290	0.8	20	30	14

**General:**

Air Inlet Size: 1/4" NPT • Recommended Hose Size: 3/8" (10 mm) • Performance rated @ 90 psig (6.2 bar) air pressure

**Standard Equipment:**

Parts List • Safety and Instruction Manual

**Accessories:**

Drill Accessories, see page 19

**Sealant Removal Cutters**

Sioux Part Number	Description
SR40	#3 (0.40") SR Cutter
SR83	#8 (0.83") SR Cutter

Sold in case of 40



SR40



SR83



**SAFETY PRECAUTION:** Read and follow all safety and operating instructions.  
**WARNING:** Face & eye protection must be worn while operating power tools, per ANSI B186.1

LARGE ANGLE DRILLS

**Performance:**

Power: 0.80 hp (0.60 kW) – 1 hp (0.75 kW)  
 Speed Range: 300 rpm – 3,000 rpm  
 Chuck Capacity: 1/4" (6 mm) – 1/2" (13 mm)

**Features:**

Reversible and Non-Reversible  
 Lever Start  
 Heads can be rotated 360°  
 Rear or Side Exhaust

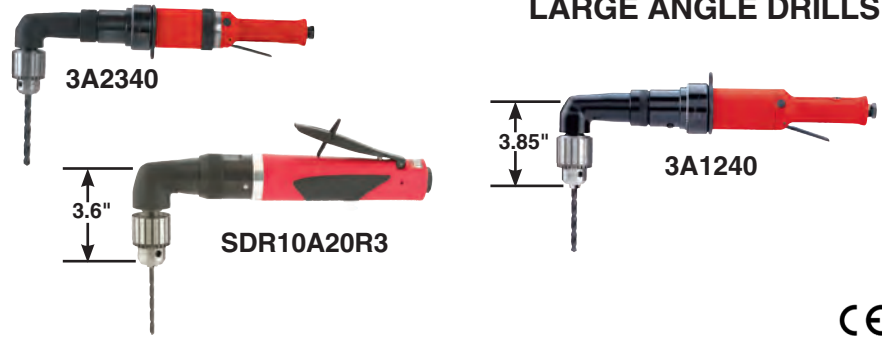

**Right Angle Drills**

Model Number	Chuck Capacity		Free Speed rpm	Weight		Length		Side To Center		Maximum Air Consumption		Spindle Thread
	in	mm		lb	kg	in	mm	in	mm	cfm	l/s	
<b>0.80 hp (0.60 kW) – Reversible – Side Exhaust<sup>1</sup></b>												
3A2140 <sup>1</sup>	1/2	13	300	6.9	3.10	15.5	394	0.8	19	33	16	1/2"-20
3A2240 <sup>1</sup>	1/2	13	480	6.9	3.10	15.5	394	0.8	19	33	16	1/2"-20
3A2340 <sup>1</sup>	1/2	13	700	6.9	3.10	15.5	394	0.8	19	33	16	1/2"-20
3A2430 <sup>1</sup>	3/8	10	1000	6.3	2.90	15.4	391	0.8	19	33	16	1/2"-20
<b>1 hp (0.75 kW) – Reversible</b>												
SDR10A3R3	3/8	10	300	3.3	1.50	12.0	305	0.8	19	30	14	3/8"-24
SDR10A3R4	1/2	13	300	3.7	1.65	12.0	305	0.8	19	30	14	3/8"-24
SDR10A6R3	3/8	10	600	3.3	1.50	12.0	305	0.8	19	30	14	3/8"-24
SDR10A6R4	1/2	13	600	3.7	1.65	12.0	305	0.8	19	30	14	3/8"-24
SDR10A10R3	3/8	10	1000	3.3	1.50	12.0	305	0.8	19	30	14	3/8"-24
SDR10A10R4	1/2	13	1000	3.7	1.65	12.0	305	0.8	19	30	14	3/8"-24
SDR10A16R2	1/4	6	1600	3.2	1.40	12.0	305	0.8	19	30	14	3/8"-24
SDR10A16R3	3/8	10	1600	3.3	1.50	12.0	305	0.8	19	30	14	3/8"-24
SDR10A20R2	1/4	6	2000	2.9	1.30	11.0	280	0.8	19	30	14	3/8"-24
SDR10A20R3	3/8	10	2000	3.0	1.35	11.0	280	0.8	19	30	14	3/8"-24
<b>1 hp (0.75 kW) – Non-Reversible</b>												
SDR10A4N3	3/8	10	400	3.3	1.50	11.2	285	0.8	19	30	14	3/8"-24
SDR10A4N4	1/2	13	400	3.7	1.65	11.2	285	0.8	19	30	14	3/8"-24
SDR10A10N3	3/8	10	1000	3.3	1.50	11.2	285	0.8	19	30	14	3/8"-24
SDR10A10N4	1/2	13	1000	3.7	1.65	11.2	285	0.8	19	30	14	3/8"-24
SDR10A13N2	1/4	6	1300	3.2	1.40	11.2	285	0.8	19	30	14	3/8"-24
SDR10A13N3	3/8	10	1300	3.3	1.50	11.2	285	0.8	19	30	14	3/8"-24
SDR10A22N2	1/4	6	2200	2.9	1.30	10.2	260	0.8	19	30	14	3/8"-24
SDR10A22N3	3/8	10	2200	3.0	1.35	10.2	260	0.8	19	30	14	3/8"-24
SDR10A30N2	1/4	6	3000	2.9	1.30	10.2	260	0.8	19	30	14	3/8"-24
<b>1 hp (0.75 kW) – Non-reversible – Side Exhaust<sup>1</sup></b>												
3A1140 <sup>1</sup>	1/2	13	360	6.5	2.90	15.1	384	0.8	19	33	16	1/2"-20
3A1240 <sup>1</sup>	1/2	13	600	6.5	2.90	15.1	384	0.8	19	33	16	1/2"-20
3A1530	3/8	10	1800	6.5	2.90	15.1	384	0.8	19	33	16	1/2"-20

<sup>1</sup> Not CE Certified

**General:** Air Inlet Size: 1/4" NPT • Recommended Hose Size: 3/8" (10 mm) • Performance rated @ 90 psig (6.2 bar) air pressure  
**Standard Equipment:** Parts List • Safety and Instruction Manual • 3-jaw Chuck and Key  
**Accessories:** Drill Accessories, see page 19

**D-HANDLE DRILLS**

**Performance:**

Power: 1 hp (0.75 kW)  
 Speed Range: 375 rpm – 2,000 rpm  
 Chuck Capacity: 3/8" (10 mm) – 1/2" (13 mm)

**Features:**

Side Exhaust  
 Support Handle Included  
 Swivel Air Inlet



**D-Handle Drills**

Model Number	Chuck Capacity		Free Speed rpm	Weight		Length		Side To Center		Maximum Air Consumption		Spindle Thread
	in	mm		lb	kg	in	mm	in	mm	cfm	l/s	
<b>"D" Handle Drill – 1 hp (0.75 kW) – Non-Reversible</b>												
DR1467	1/2	13	375	6.6	3	13.4	340	1	25	30	14	1/2"-20
1466	1/2	13	550	6.6	3	13.4	340	1	25	30	14	1/2"-20
1465-1/2	1/2	13	1000	6.6	3	13.4	340	1	25	30	14	1/2"-20
1464	1/2	13	2000	6.6	3	13.4	340	1	25	30	14	1/2"-20
1465	3/8	10	1000	6.6	3	13.3	338	1	25	30	14	1/2"-20

**General:** Air Inlet Size: 1/4" NPT • Recommended Hose Size: 3/8" (10 mm) • Performance rated @ 90 psig (6.2 bar) air pressure  
**Standard Equipment:** Parts List • Safety and Instruction Manual • 3-jaw Chuck and Key • Swivel Air Inlet  
**Accessories:** Drill Accessories, see page 19

**WARNING:** SAFETY PRECAUTION: Read and follow all safety and operating instructions. **WARNING:** Face & eye protection must be worn while operating power tools, per ANSI B186.1



T-HANDLE DRILLS

**Performance:**

Power: 1 hp (0.75 kW)  
 Speed Range: 360 rpm – 4,000 rpm  
 Chuck Capacity: 3/8" (10 mm) – 1/2" (13 mm)

**Features:**

Lever Start  
 Handle Grips



SDR10T26N4



3T1630

T-Handle Drills

Model Number	Chuck Capacity		Free Speed rpm	Weight		Length		Maximum Air Consumption		Spindle Thread
	in	mm		lb	kg	in	mm	cfm	l/s	
<b>Signature Series – 1 hp (0.75 kW) – Non-reversible</b>										
SDR10T4N4	1/2	13	400	6.3	2.9	36	914	35	17	1/2"-20
SDR10T7N4	1/2	13	700	6.3	2.9	36	914	35	17	1/2"-20
SDR10T12N4	1/2	13	1200	6.3	2.9	36	914	35	17	1/2"-20
SDR10T16N4	1/2	13	1600	6.3	2.9	36	914	35	17	1/2"-20
SDR10T26N3	3/8	10	2600	5.6	2.5	36	914	35	17	3/8"-24
SDR10T26N4	1/2	13	2600	5.9	2.7	36	914	35	17	1/2"-20
SDR10T40N3	3/8	10	4000	5.6	2.5	36	914	35	17	3/8"-20
<b>3 - Series – 1 hp (0.75 kW) – Non-reversible</b>										
3T1140	1/2	13	360	7.6	3.5	35	889	35	17	1/2"-20
3T1340	1/2	13	1000	7.6	3.5	35	889	35	17	1/2"-20
3T1530	3/8	10	2150	7.3	3.3	35	889	35	17	1/2"-20
3T1630	3/8	10	2650	7.3	3.3	35	889	35	17	1/2"-20
3T1640	1/2	13	2650	7.4	3.4	35	889	35	17	1/2"-20

**General:** Air Inlet Size: 1/4" NPT • Recommended Hose Size: 3/8" (10 mm) • Performance rated @ 90 psig (6.2 bar) air pressure  
**Standard Equipment:** Parts List • Safety and Instruction Manual • 3-jaw Chuck and Key • Comfort Grip  
**Accessories:** Drill Accessories, see page 19

Z-HANDLE DRILLS

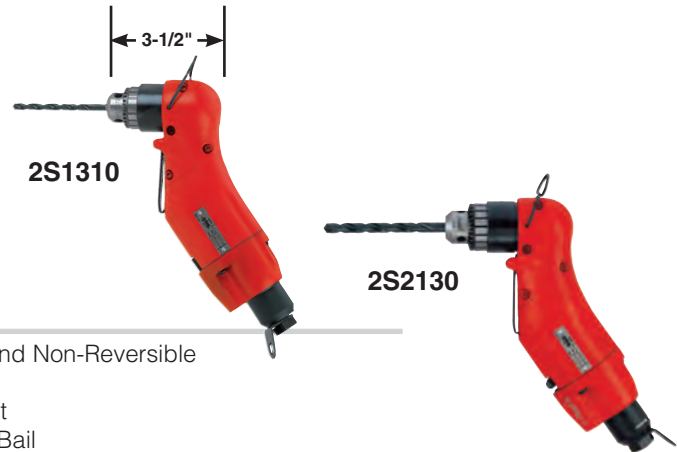

2S1310

2S2130

**Performance:**

Power: 0.33 hp (0.25 kW) – 0.50 hp (0.37 kW)  
 Speed Range: 1,000 rpm – 2,200 rpm  
 Chuck Capacity: 1/4" (6 mm) – 3/8" (10 mm)

**Features:**

Reversible and Non-Reversible  
 Lever Start  
 Rear Exhaust  
 Suspension Bail

Z-Handle Drills

Model Number	Chuck Capacity		Free Speed rpm	Weight		Length		Side To Center		Maximum Air Consumption		Spindle Thread
	in	mm		lb	kg	in	mm	in	mm	cfm	l/s	
<b>Non-reversible – 0.50 hp (0.37 kW)</b>												
2S1310	1/4	6	2200	2.6	1.2	3.5	89	1	25	18	8	3/8"-24
2S1330	3/8	10	2200	2.7	1.2	3.8	97	1	25	18	8	3/8"-24
<b>Reversible – 0.33 hp (0.25 kW)</b>												
2S2110	1/4	6	1000	2.6	1.2	3.5	89	1	25	16	8	3/8"-24
2S2130	3/8	10	1000	2.7	1.2	3.8	97	1	25	16	8	3/8"-24
2S2230	3/8	10	1600	2.7	1.2	3.8	97	1	25	16	8	3/8"-24
2S2310	1/4	6	2200	2.6	1.2	3.5	89	1	25	16	8	3/8"-24
2S2330	3/8	10	2200	2.7	1.2	3.8	97	1	25	16	8	3/8"-24

**General:** Air Inlet Size: 1/4" NPT • Recommended Hose Size: 3/8" (10 mm) • Performance rated @ 90 psig (6.2 bar) air pressure  
**Standard Equipment:** Parts List • Safety and Instruction Manual • 3-jaw Chuck and Key • Suspension Bail  
**Accessories:** Drill Accessories, see page 19



**SAFETY PRECAUTION:** Read and follow all safety and operating instructions.  
**WARNING:** Face & eye protection must be worn while operating power tools, per ANSI B186.1

### Drill Chucks & Keys



SP21019T



SP21019B



SP21133



SP21132



SP21002



SP21131



SP21137



SP67398



SP67397



74375



69005



69006

Chuck Capacity	Thread Size	Chuck Part No	Key Part No	Key Holder No
0 – 1/4"	3/8"-24	SP21019T	30202	
0 – 1/4"	3/8"-24	SP21019B	30000	
1/16" – 3/8"	3/8"-24	SP21133	30002	14273
5/64" – 1/2"	3/8"-24	SP21132	30429	
0 – 3/8"	1/2"-20	SP21002	30011	14273
1/16" – 3/8"	1/2"-20	SP21131	30002	
5/64" – 1/2"	1/2"-20	SP21137	30011	14273
0" – 1/2"	1/2"-20	SP74222	30429	
1/32" – 3/8" <sup>1</sup>	3/8"-24	SP67398		
1/16" – 1/2" <sup>1</sup>	1/2"-20	SP67397		
0 – 1/4"	3/8"-24	74375		
0 – 3/8" <sup>1</sup>	3/8"-24	69005		
0 – 1/2" <sup>1</sup>	1/2"-20	69006		

<sup>1</sup>Keyless Chuck • Keyed chucks include key

### Quick Change Chuck

#### Part No 2352

Adapts 3/8"-24 threaded spindles to 1/4" hex quick change

Non-Reversing Only



### Sealant Removal Cutters



SR40



SR83

Sioux Part Number	Description
SR40	#3 (0.40") SR Cutter
SR83	#8 (0.83") SR Cutter

Sold in case of 40

### Support Handles



2355B



77067A

Sioux Part Number	Description
2355B	For use on ES, 2L, 3P series drills
77117A	For use on 4P, 5P series drills
77067A	6P, 10P series drills

### Comfort Grips

For use on #1 series straight drills



66124

For use on SDR4P pistol grip drills



68340

For use on Signature series drills



SDR6PNBOOT / SDR10PNBOOT



**SAFETY PRECAUTION:** Read and follow all safety and operating instructions.  
**WARNING:** Face & eye protection must be worn while operating power tools, per ANSI B186.1

# ASSEMBLY



**Index**

<b>Screwdrivers</b> .....	<b>25 – 29</b>
<b>Nutrunners</b> .....	<b>30</b>
<b>Ratchet Wrenches</b> .....	<b>31</b>

<b>Impact Drivers</b> .....	<b>33</b>
<b>Impact Wrenches</b> .....	<b>34 – 35</b>
<b>Assembly Accessories</b> .....	<b>36</b>



# ASSEMBLY

Combining Efficiency, Reliability and Value...

## Putting it all together

To keep up with the rapidly growing demands of modern assembly applications, Sioux Tools remains on the cutting edge of engineering design. We continue to be innovative in creating new tools to provide faster rundown speeds with exceptional accuracy and consistent torque delivery, combined with ergonomic design for operator comfort and safety.

We build every tool to help assembly operators become more productive. We believe they deserve tools that will help improve their quality of performance and maximize the skills they bring to the job.

## Exclusive Designs

Sioux Tools is the exclusive manufacturer of the Z-handle. This unique feature allows access to tight, hard to reach angles.

## Impact Wrenches

Suitable for general assembly, repair jobs etc. When you require a powerful, lightweight tool, with little reaction force and moderate accuracy. This is the best choice for loosening joints.

## Screwdrivers

Sioux Tools offers a wide range of screwdrivers designed to meet today's fast paced, high output assembly and manufacturing applications.

## Nutrunners

Sioux offers nutrunners that are designed for high volume industrial production. You can choose from free speeds of up to 2200 rpm, and a torque range of up to 600 in lb (68 Nm). These are outstanding tools for fast accurate assembly.

## Assembly Safety

**Broken sockets, bits and adapters can cause injury.**

Proper eye protection must be worn at all times by tool user and bystanders. Use only sockets, bits and adapters made for power tools and that are in good condition. Use only bits and adapters that are in good condition. Keep hands away from sockets, bits and adapters.

**Sudden and unexpected tool movement can cause injury.**

Be sure your body position allows you to have control of the tool at all times. Make sure your footing is secure. Consult manufacturer for proper reaction bar if movement is excessive.

**Tools starting unexpectedly can cause injury.**

Always remove the tool from air supply and activate trigger to bleed air line before making any adjustments, changing accessories, or doing any maintenance or service on the tool.

**Falling tools can cause injury.**

If the tool is used with a balancer or other suspension device, be sure the tool is firmly attached to the device.

## Assembly Principles of Operation

An air motor and planetary reduction gearing are used to drive a clutch spindle, producing torque in a fastener.

The action of the torque creates clamp-load in the assembly.

Motor size (horsepower), gear ratio, and type of clutch determine performance, and are key factors in selecting the appropriate tool for a given application.

Generally equipped with a 1/4" female hexagon spindle that allows inserting a screwdriver bit.

## An Easy Drive Home



Sioux Tools offers a wide range of screwdrivers and nutrunners designed to meet today's fast paced, high output assembly and manufacturing applications. Sioux Tools is able to provide a perfect match for any job requirement. As industries strive to reduce fastener requirements, we work to meet the demand for greater accuracy and precision in fastening performance. The productivity demands for quality and speed, as well as user comfort, convenience and safety make Sioux Tools your number one choice.

## Configurations

Sioux screwdrivers are available in pistol grip, inline, right angle and our exclusive Z-handle configurations. Most screwdriver models offer your choice of Quick Change or Locking Internal Hex spindles. The spring-loaded chuck on the Quick Change

allows for fast, easy bit changes without the need for additional tools or hardware. The slimmer design of the Locking Internal Hex ensures that the bit stays firmly in place until you choose to remove it with the aid of a vise or pliers.

## Reducing Physical Load

We design all our screwdrivers with ergonomics in mind. We help you get the job done with a minimum amount of effort and wear and tear on the operator. By reducing the physical load on the operator, which includes noise and oil mist, productivity will be improved. Sioux Tools offers many benefits including high torque accuracy, low sound levels and ergonomic grips. Fast clutch shutoff reduces reaction force, while the shape reduces the amount of gripping and trigger force required.

## Clutch Selection

**Positive Clutch** – Spindle will not turn with motor until operator exerts forward pressure on spindle engaging the clutch. The clutch ratchets when torque resistance from the fastener overcomes the forward pressure and the jaws begin to cam apart. Torque output of the tool is determined by forward pressure from operator and by the cam angle of the clutch jaws. For wood, sheet metal, and machine screws and lag bolts.

Sioux Tools is the exclusive manufacturer of three different positive clutches; Low, Mid and High torque output. Your choice of clutch allows you to more precisely control the amount of torque exerted on the fastener.

**Stall Drive** – Spindle is coupled directly with the output of the motor. Final torque is reached when resistance of the fastener overcomes the torque output of the motor. Final torque can be influenced by air pressure and/or operator twisting the tool.







For prevailing torque or soft pull applications involving machine, wood, or self-tapping screws.

**Adjustable Clutch** – Spindle will not turn with motor until operator exerts forward pressure on spindle engaging the clutch. When fastener is tight, clutch will ratchet. Adjusting spring pressure will effect final output torque. Offers consistent torque control with little operator reaction.

**Torque Control** – Motor shuts off automatically when fastener is tight. Adjusting spring pressure changes final output torque for critical torque requirements. Perfect for applications with little or no prevailing torque where final torque is substantially higher than rundown torque.

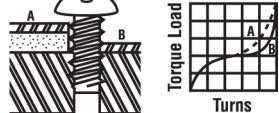
**Direct Clutch** – Spindle will not turn with motor until operator exerts forward pressure on spindle engaging the clutch. Final torque is reached when resistance of the fastener overcomes the torque output of the motor. Excellent stall type tool when tightening group of fasteners without turning off motor.

### Clutch Selection Guide

Type of Job	Clutch Performance			
	Torque Control	Adjustable	Direct/Stall Drive	Positive Clutch
<p><b>1. Free-Running – Sudden Stop</b></p>  <p>Turns easily until screw head or nut seats against a solid stop. Resistance then builds up suddenly.</p>	Excellent for all size screws.	Good for all size screws. Close torque control is not required.	Good for large or medium nuts or cap screws only.	Fair for all size screws where close torque accuracy is not required.
<p><b>2. Soft Pull-Up</b></p>  <p>Turns easily until screw head or nut seats, then resistance builds up gradually through one or more turns as resilient material compressed.</p>	Excellent for all size screws.	Good for most screws. Close torque control is not required. Slow on large screws with long pull-up.	Good for large and medium size screws. Must be adjusted to run rather slowly for small screws.	Good for small to medium size screws. Requires considerable operator pressure on large screws.
<p><b>3. Self-Tapping in Thick Material</b></p>  <p>Increasing heavy resistance through entire travel until screw head seats. Then either (A) gradual, or (B) sudden final build-up resistance.</p>	Excellent for all size screws. Not suitable if tapping torque exceeds stripping torque.	Good for most screws. With proper operator technique, can be used where tapping torque exceeds stripping torque. Slow on large screws.	Not recommended unless stripping torque is considerably higher than tapping torque.	Good for most size screws where stripping torque is considerably higher than tapping torque. Excellent in non-uniform or misaligned material.
<p><b>4. Sheet Metal Screws</b></p>  <p>Resistance increases rapidly at first, then eases slightly. At the end, it usually builds up suddenly when screw head seats.</p>	Good for all size screws. Not suitable if tapping torque exceeds stripping torque.	Good for most screws. With proper operator technique, can be used where tapping torque exceeds stripping torque.	Not recommended unless stripping torque is considerably higher than tapping torque.	Good for all size screws where stripping torque is considerably higher than tapping torque. Excellent when sheets are frequently misaligned.
<p><b>5. Lock Nuts</b></p>  <p>Starts with heavy resistance that last through entire travel until screw or nut seats. Then either (A) gradual, or (B) sudden further build-up resistance.</p>	Excellent for all size screws.	Good for most screws. Close torque control is not required.	Good for large and medium screws. Must be adjusted to run rather slowly for small screws.	Fair for all size screws.
<p><b>6. Wood Screws</b></p>  <p>Starts with small resistance that steadily increases through entire travel with additional resistance as screw head seats.</p>	Fair for all size screws.	Good for all size screws.	Excellent for large and medium screws. Must be adjusted to run rather slowly for small screws.	Excellent for all size screws.

# Tool Selection Guide

## Considerations for Selecting Screwdrivers

This should be done in a systematic way to ensure no details are overlooked that could have an adverse affect on job function or results. The following are variables that must be considered to ensure proper tool selection.

- What is being assembled?
- What material is involved?
- What type of screw or nut is being driven? What head type?
- What screw size (standard or metric)?
- What U.S. grade or metric class?
- What torque (inch pounds or Newton meters)?
- What torque tolerance (accuracy)?
- What is the run-down torque vs. seating torque?
- What type of joint pull-up (hard, medium, soft)?
- What pull-up conditions (free run-down, sheet metal, wood, or plastic)?
- What is the production rate?
- Are there clearance problems?
- What handle style is required (straight or pistol)?
- Is the tool to be hand held or fixtured?
- What type of clutch?
- Speed required?
- Is there a need for a reversible tool?
- What type of drive (square, 1/4" hex, quick change)?
- How is the application being done now?
- Special consideration?

## What is the size and type of screw or fastener on which the tool will be used?

- No 1 Series Tools** – 2 to 50 in lb of torque. (Fasteners up to 1/4")
- .6 & 1 HP Signature Series Tools** – 5 to 400 in lbs of torque. (Fasteners up to 3/8")
- No 3 Series Tools** – 5 to 50 ft lbs of torque. (Fasteners up to 1/2")

## What kind of application and material will the fastener be used on?

The type of material helps to determine which type of clutch is needed.

### Application & Material Guide

Screw Size				
	Clutch	Free Run Down	Soft Pull-Up	Prevailing Torque
<b>No 8 and Smaller</b>	Adjustable	Excellent	Excellent	Excellent
	Stall	Excellent	Good	Excellent
	Direct	Good	Good	Good
	Positive	Fair	Fair	Good
<b>No 10 and Larger</b>	Adjustable	Good	Fair	Fair
	Stall	Good	Excellent	Excellent
	Direct	Good	Excellent	Excellent
	Positive "P"	Good	Excellent	Excellent
	Positive "PS"	Good	Excellent	Excellent

## What are the torque requirements?

Most air tools share the quality: as the speed increases, the torque decreases. This applies to tools within the same horsepower rating.

- A.** Stall or direct clutch gives the most torque.
- B.** Positive clutch tools are operator influenced.
- C.** Adjustable torque clutches are available on most Sioux fastening tools.
- D.** Torque control is available on No 1

## At what angle or position will the tool be used?

This will determine the style of tool best suited from an ergonomics point of view.

- A.** If the fastener is in a vertical position, a straight or lever style tool will be best.
- B.** If the fastener is in a horizontal position a pistol style tool will be best.
- C.** If the fastener is in a tight or constricted area the "2S" series works well in this application.

## Is reversing necessary?

Most fastening applications are going to require a reversible tool. Keep in mind that in most cases a non-reversing tool will have more torque than a reversible tool.

## Is the application operator influenced or restricted?

- A.** Is the operator male or female? This can be a factor in determining the size of the power tool (weight for example).
- B.** Does the application lend itself to an auto start tool, as in the No 1 series?

## An example of applying these questions to an application would be:

Driving a 2" long wood screw into hardwood with a pilot hole. The fastener is in a horizontal position during assembly. A test with a hand torque wrench indicates a prevailing torque of 80 in lbs, and a failing torque of 120 in lbs.

- 1.** 2" long wood screw
- 2.** Hard Wood use positive clutch
- 3.** SSD10P20PS – 100 in lbs
- 4.** Pistol will work best
- 5.** Need reversing
- 6.** Mostly male workers































# Screwdriver Maintenance



- 1 Tipper valve and valve seat is easily accessible for service
- 2 Slip fit of front end plate bearing allows easy service of the air motor without disturbing the rotor spacing
- 3 Rotor pinion is case hardened to resist wear
- 4 Grease zerk makes it easy to grease the gears without disassembly
- 5 Ring gear is machined into the motor retainer for ease of assembly and disassembly
- 6 Planet gear pins are slip fit for ease of assembly and disassembly
- 7 Interchangeable rotor, cylinder, bearings and end plates. This reduces the number of spare parts tool cribs need to stock

## Guide to Fasteners

### Guide To Fasteners

Screw Type	Standard Nosepieces Available For All Fasteners Shown Below				
<b>Wood Screws</b>	 <i>flat head</i>	 <i>round head</i>	 <i>oval head</i>		
<b>Machine Screws</b>	 <i>round head</i>	 <i>flat head</i>	 <i>fillister head</i>	 <i>oval head</i>	
	 <i>truss head</i>	 <i>binding head</i>	 <i>washer head*</i>	 <i>pan head</i>	
	 <i>flat side binding head</i>	 <i>fillister pan head</i>	 <i>flat fillister head</i>	 <i>undercut flat head</i>	
	 <i>knob screw head</i>	 <i>lentil head</i>	 <i>Jackson head</i>	 <i>undercut oval head</i>	
<b>Tapping or Sheet Metal Screws</b>	 <i>round head</i>	 <i>flat head</i>	 <i>oval head</i>	 <i>pan head</i>	
				 <i>truss head</i>	
<b>Drive Systems</b>	<b>Standard</b>			<b>Special*</b>	
	 <i>Phillips</i>	 <i>Reed -Prince</i>	 <i>slotted</i>	 <i>clutch</i>	 <i>Torx</i>

\* Standard or Special, depending on the washer diameter.

\* Special bits required for Clutch and Torx internal and external. Call factory.

POSITIVE CLUTCH PISTOL GRIP & T-HANDLE SCREWDRIVERS



**Performance:**

Torque: 20 in lb (2.3 Nm) – 216 in lb (24.4 Nm)  
Speed: 500 rpm – 2,500 rpm

**Features:**

Reversible and Non-reversible  
Trigger or Shuttle Reverse  
Comfort Grip



Positive Clutch Pistol Grip & T-Handle Screwdrivers

Model Number	Max Torque <sup>1</sup> (Soft Joint)		Free Speed rpm	Weight		Length		Side To Center		Air Consumption	
	in lb	Nm		lb	kg	in	mm	in	mm	cfm	l/s
<b>0.4 hp (0.3 kW) Trigger Start - Shuttle Reverse</b>											
SSD4P5P	95	10.7	500	1.8	0.8	7.0	178	0.7	17	20	10
SSD4P7P	65	7.3	700	1.8	0.8	7.0	178	0.7	17	20	10
SSD4P11P	45	5.1	1100	1.8	0.8	7.0	178	0.7	17	20	10
SSD4P14P	35	3.9	1400	1.6	0.7	6.5	165	0.7	17	20	10
SSD4P18P	26	2.9	1800	1.6	0.7	6.5	165	0.7	17	20	10
SSD4P26P	20	2.3	2600	1.6	0.7	6.5	165	0.7	17	20	10
<b>0.6 hp (0.45 kW) Medium Clutch Screwdrivers – 1/4" Quick Change</b>											
SSD6P12P	100	11.3	1200	2.6	1.18	8.6	218	0.8	20	25	12
SSD6P20P	55	6.2	2000	2.2	0.98	6.8	171	0.8	20	25	12
SSD6P20PSRR	55	6.2	2000	2.2	0.98	6.8	171	0.8	20	25	12
SSD6P25P	40	4.5	2500	2.2	0.98	6.8	171	0.8	20	25	12
SSD6P25PSRR	40	4.5	2500	2.2	0.98	6.8	171	0.8	20	25	12
<b>1 hp (0.75 kW) Medium Torque Clutch Screwdrivers – 1/4" Quick Change</b>											
SSD10P12P	135	15.3	1200	2.8	1.30	9.1	231	0.8	20	30	14
SSD10P20P	70	7.9	2000	2.4	1.07	7.3	185	0.8	20	30	14
SSD10P25P	50	5.7	2500	2.4	1.07	7.3	185	0.8	20	30	14
<b>1 hp (0.75 kW) High Torque Clutch Screwdrivers – 1/4" Quick Change</b>											
SSD10P12PS	145	16.4	1200	2.8	1.30	9.1	231	0.8	20	30	14
SSD10P20PS	80	9.0	2000	2.4	1.07	7.3	185	0.8	20	30	14
SSD10P25PS	58	6.5	2500	2.4	1.07	7.3	185	0.8	20	30	14
<b>1 hp (0.75 kW) – Medium Torque Positive Clutch Rapid Reverse Screwdriver</b>											
SSD10P20PRR	70	7.9	2000	2.4	1.07	7.3	185	0.8	20	30	14
SSD10P25PRR	50	5.7	2500	2.4	1.07	7.3	185	0.8	20	30	14
<b>3 Series T-Handle – 7/16" Quick Change</b>											
3T2303 <sup>1</sup>	216	24.4	850	6.7	3.0	33	840	1	25	33	16

<sup>1</sup> Torque output varies with force exerted by operator

**General:**

Air Inlet Size: 1/4" NPT • Recommended Hose Size: 1/4" (6 mm) • Performance rated @ 90 psig (6.2 bar) air pressure

**Standard Equipment:**

Parts List • Safety and Instruction Manual

**Accessories:**

Screwdriver Accessories, Screwdriver Bits and Finders see page 36



**SAFETY PRECAUTION:** Read and follow all safety and operating instructions.  
**WARNING:** Face & eye protection must be worn while operating power tools, per ANSI B186.1

POSITIVE CLUTCH INLINE SCREWDRIVER

**Performance:**

Torque: 55 in lb (6.2 Nm)  
Speed: 800 rpm

**Features:**

Reversible  
Lever Start  
Rear Exhaust



Positive Clutch Inline Screwdrivers

Model Number	Max Torque <sup>1</sup> (Soft Joint)		Free Speed	Weight		Length		Side To Center		Air Consumption		
	1/4" Quick Change	in lb		Nm	lb	kg	in	mm	in	mm	cfm	l/s
<b>Inline</b>												
1SM2103		55	6.2	800	1.4	0.6	9.1	231	0.6	15	8	4

<sup>1</sup> Torque output varies with force exerted by operator

**General:**

Air Inlet Size: 1/4" NPT • Recommended Hose Size: 1/4" (6 mm) (1SM series) • Performance rated @ 90 psig (6.2 bar) air pressure

**Standard Equipment:**

Parts List • Safety and Instruction Manual • Comfort Grip (1SM series)

**Accessories:**

Screwdriver Accessories, Screwdriver Bits and Finders see page 36

STALL PISTOL GRIP SCREWDRIVERS

**Performance:**

Torque: 20 in lb (2.3 Nm) –  
400 in lb (45.2 Nm)  
Speed: 300 rpm – 2,600 rpm

**Features:**

Reversible  
Rapid or Shuttle Reverse  
Comfort Grip  
1/4" Quick Change



Stall Pistol Grip Screwdrivers

Model Number	Max Torque (Soft Joint)		Free Speed	Weight		Length		Side To Center		Air Consumption	
	in lb	Nm		lb	kg	in	mm	in	mm	cfm	l/s
<b>0.4 hp (0.3 kW) Trigger Start - Shuttle Reverse</b>											
SSD4P5S	95	10.7	500	1.5	0.7	5.5	140	0.7	17	20	10
SSD4P7S	65	7.3	700	1.5	0.7	5.5	140	0.7	17	20	10
SSD4P11S	45	5.1	1100	1.5	0.7	5.5	140	0.7	17	20	10
SSD4P14S	35	3.9	1400	1.3	0.6	5.0	127	0.7	17	20	10
SSD4P18S	26	2.9	1800	1.3	0.6	5.0	127	0.7	17	20	10
SSD4P26S	20	2.3	2600	1.3	0.6	5.0	127	0.7	17	20	10
<b>0.6 hp (0.45 kW) Trigger Start – Shuttle Reverse</b>											
SSD6P7S	155	17.8	700	2.4	1.10	6.8	171	0.8	20	25	12
SSD6P12S	100	11.3	1200	2.4	1.10	6.8	171	0.8	20	25	12
SSD6P20S	55	6.2	2000	2.0	0.90	5.8	146	0.8	20	25	12
SSD6P25S	40	4.5	2500	2.0	0.90	5.8	146	0.8	20	25	12
<b>0.6 hp (0.45 kW) Trigger Start – Rapid Reverse</b>											
SSD6P20SRR	55	6.2	2000	2.0	0.90	5.8	146	0.8	20	25	12
<b>1 hp (0.75 kW) Trigger Start – Shuttle Reverse</b>											
SSD10P3S	400	45.2	300	2.6	1.17	7.5	191	0.8	20	30	14
SSD10P5S	325	36.7	500	2.6	1.17	7.5	191	0.8	20	30	14
SSD10P7S	220	24.9	700	2.6	1.17	7.5	191	0.8	20	30	14
SSD10P12S	145	16.4	1200	2.6	1.17	7.5	191	0.8	20	30	14
SSD10P20S	80	9.0	2000	2.2	0.98	6.5	165	0.8	20	30	14
SSD10P25S	58	6.6	2500	2.2	0.98	6.5	165	0.8	20	30	14
<b>1 hp (0.75 kW) – Stall Rapid Reverse</b>											
SSD10P20SRR	80	9.0	2000	2.2	0.98	6.5	165	0.8	20	30	14

**General:**

Air Inlet Size: 1/4" NPT • Recommended Hose Size: 1/4" (6 mm) (1OM series); 3/8" (10 mm) • Performance rated @ 90 psig (6.2 bar) air pressure

**Standard Equipment:**

Parts List • Safety and Instruction Manual • Comfort Grip

**Accessories:**

Screwdriver Accessories, Screwdriver Bits and Finders see pages 36



**SAFETY PRECAUTION:** Read and follow all safety and operating instructions.

**WARNING:** Face & eye protection must be worn while operating power tools, per ANSI B186.1



STALL INLINE SCREWDRIVERS

**Performance:**

Torque: 24 in lb (2.7 Nm) – 400 in lb (45.2 Nm)  
Speed: 300 rpm – 2,500 rpm

**Features:**

Reversible  
Lever Start  
Rear Exhaust  
Suspension Bail  
1/4" Quick Change

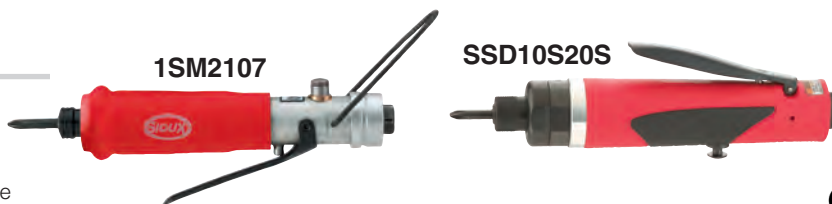

**Stall Inline Screwdrivers**

Model Number	Max Torque (Soft Joint)		Free Speed rpm	Weight		Length		Side To Center		Air Consumption	
	in lb	Nm		lb	kg	in	mm	in	mm	cfm	l/s
<b>Inline – Reversible – 1/4" Quick Change Drive</b>											
1SM2107	55	6.2	800	1.4	0.60	9.1	231	0.6	15	8	4
1SM2407	24	2.7	2200	1.3	0.60	8.1	206	0.6	15	8	4
<b>Inline – Stall Clutch</b>											
SSD10S3S	400	45.2	300	2.2	1.00	9.5	240	0.8	20	30	14
SSD10S5S	325	36.7	500	2.2	1.00	9.5	240	0.8	20	30	14
SSD10S7S	220	24.9	700	2.2	1.00	9.5	240	0.8	20	30	14
SSD10S12S	145	16.4	1200	2.2	1.00	9.5	240	0.8	20	30	14
SSD10S20S	80	9.0	2000	1.9	0.85	8.4	215	0.8	20	30	14
SSD10S25S	58	6.6	2500	1.9	0.85	8.4	215	0.8	20	30	14

**General:** Air Inlet Size: 1/4" NPT • Recommended Hose Size: 1/4" (6 mm) (1SM series); 3/8" (10 mm) (SSD series) • Performance rated @ 90 psig (6.2 bar) air pressure  
**Standard Equipment:** Parts List • Safety and Instruction Manual • Comfort Grip (1SM series) • Suspension Bail  
**Accessories:** Screwdriver Accessories, Screwdriver Bits and Finders see page 36

ADJUSTABLE CLUTCH PISTOL GRIP SCREWDRIVERS

**Performance:**

Torque: 23 in lb (2.6 Nm) – 140 in lb (15.8 Nm)  
Speed: 300 rpm – 2,600 rpm

**Features:**

Reversible  
Rapid or Shuttle Reverse  
Comfort Grip



**Adjustable Clutch Pistol Grip Screwdrivers**

Model Number	Max Torque (Soft Joint)		Free Speed rpm	Weight		Length		Side To Center		Air Consumption	
	in lb	Nm		lb	kg	in	mm	in	mm	cfm	l/s
<b>0.4 hp (0.3 kW) Trigger Start - Shuttle Reverse</b>											
SSD4P5AC	70	7.9	500	2.1	1.0	8.5	216	0.7	17	20	10
SSD4P7AC	60	6.8	700	2.1	1.0	8.5	216	0.7	17	20	10
SSD4P11AC	40	4.5	1100	2.1	1.0	8.5	216	0.7	17	20	10
SSD4P14AC	30	3.4	1400	1.9	0.9	8.0	203	0.7	17	20	10
SSD4P18AC	23	2.6	1800	1.9	0.9	8.0	203	0.7	17	20	10
SSD4P26AC	17	1.9	2600	1.9	0.9	8.0	203	0.7	17	20	10
<b>0.6 hp (0.45 kW) Trigger Start – Shuttle Reverse</b>											
SSD6P7AC	140	15.8	700	3.0	1.36	10.3	262	0.8	20	25	12
SSD6P12AC	100	11.3	1200	3.0	1.36	10.3	262	0.8	20	25	12
SSD6P20AC	55	6.2	2000	2.6	1.16	8.5	216	0.8	20	25	12
SSD6P25AC	40	4.5	2500	2.6	1.16	8.5	216	0.8	20	25	12
<b>1 hp (0.75 kW) Trigger Start – Shuttle Reverse</b>											
SSD10P3AC	140	15.8	300	3.2	1.45	10.2	259	0.8	20	30	14
SSD10P5AC	140	15.8	500	3.2	1.45	10.2	259	0.8	20	30	14
SSD10P7AC	140	15.8	700	3.2	1.45	10.2	259	0.8	20	30	14
SSD10P12AC	120	13.5	1200	3.2	1.45	10.2	259	0.8	20	30	14
SSD10P20AC	80	9.0	2000	2.8	1.25	8.4	213	0.8	20	30	14
SSD10P25AC	60	6.8	2500	2.8	1.25	8.4	213	0.8	20	30	14

**General:** Air Inlet Size: 1/4" NPT • Recommended Hose Size: 1/4" (6 mm) (10M series); 3/8" (10 mm) • Performance rated @ 90 psig (6.2 bar) air pressure  
**Standard Equipment:** Parts List • Safety and Instruction Manual • Comfort Grip • Clutch Adjustment Wrench • All Applicable Clutch Springs  
**Accessories:** Screwdriver Accessories, Screwdriver Bits and Finders see page 36



**SAFETY PRECAUTION:** Read and follow all safety and operating instructions.  
**WARNING:** Face & eye protection must be worn while operating power tools, per ANSI B186.1

## ADJUSTABLE CLUTCH INLINE SCREWDRIVERS

**Performance:**

Torque: 20 in lb (2.3 Nm) – 140 in lb (15.8 Nm)  
Speed: 300 rpm – 2,500 rpm

**Features:**

Reversible  
Rear Exhaust  
External Clutch Adjustment



**Adjustable Clutch Inline Screwdrivers**



Model Number		Max Torque (Soft Joint)		Free Speed	Weight		Length		Side To Center		Air Consumption	
1/4" Quick Change	1/4" Internal Hex	in lb	Nm	rpm	lb	kg	in	mm	in	mm	cfm	l/s
<b>Inline – Lever Start</b>												
1SM2105Q		50	5.7	800	1.6	0.70	10.3	262	0.6	15	8	4
1SM2205Q		35	4.0	1100	1.6	0.70	10.3	262	0.6	15	8	4
1SM2305Q		25	2.8	1500	1.6	0.70	10.3	262	0.6	15	8	4
1SM2405Q	1SM2405	20	2.3	2200	1.4	0.60	9.3	236	0.6	15	8	4
<b>Inline – Lever Start</b>												
SSD10S3AC		140	15.8	300	2.8	1.25	12.3	315	0.8	20	30	14
SSD10S5AC		140	15.8	500	2.8	1.25	12.3	315	0.8	20	30	14
SSD10S7AC		140	15.8	700	2.8	1.25	12.3	315	0.8	20	30	14
SSD10S12AC		120	13.5	1200	2.8	1.25	12.3	315	0.8	20	30	14
SSD10S20AC		80	9.0	2000	2.5	1.15	11.2	285	0.8	20	30	14
SSD10S25AC		60	6.8	2500	2.5	1.15	11.2	285	0.8	20	30	14

**General:**

Air Inlet Size: 1/4" NPT • Recommended Hose Size: 1/4" (6 mm) (1SM series); 3/8" (10 mm) (SSD series) • Performance rated @ 90 psig (6.2 bar) air pressure

**Standard Equipment:**

Parts List • Safety and Instruction Manual • Comfort Grip (1SM series) • Suspension Bail • Clutch Adjustment Wrench • All Applicable Clutch Springs

**Accessories:**

Screwdriver Accessories, Screwdriver Bits and Finders see page 36

## TORQUE CONTROL SCREWDRIVERS

**Performance:**

Torque: 5 in lb (0.6 Nm) – 50 in lb (5.5 Nm)  
Speed: 725 rpm – 2,800 rpm

**Features:**

Push-to-Start  
Reversible  
Locking Button Reverse  
External Clutch Adjustment



**Torque Control Screwdrivers**



Model Number		Max Torque (Soft Joint)		Free Speed	Weight		Length		Side To Center		Air Consumption	
1/4" Quick Change		in lb	Nm	rpm	lb	kg	in	mm	in	mm	cfm	l/s
<b>Inline – Push To Start</b>												
1ST2108Q		5-50	0.6-5.5	800	1.6	0.7	9.3	236	0.6	15	8	4
1ST2208Q		5-35	0.6-4	1100	1.6	0.7	9.3	236	0.6	15	8	4
1ST2308Q		5-25	0.6-3	1500	1.6	0.7	9.3	236	0.6	15	8	4
1ST2508Q		5-14	0.6-1.5	2800	1.4	0.6	8.3	211	0.6	15	8	4
<b>Pistol Grip – Push To Start</b>												
1OT2108Q		5-50	0.6-5.5	725	2.1	1.0	8.8	225	0.7	17	10	5
1OT2208Q		5-35	0.6-4	1000	2.1	1.0	8.8	225	0.7	17	10	5
1OT2308Q		5-25	0.6-3	1400	2.1	1.0	8.8	225	0.7	17	10	5
1OT2508Q		5-14	0.6-1.5	2600	1.9	0.9	7.8	200	0.7	17	10	5

**General:**

Air Inlet Size: 1/4" NPT • Recommended Hose Size: 1/4" (6 mm) (1OT, 1ST series) • Performance rated @ 90 psig (6.2 bar) air pressure

**Standard Equipment:**

Parts List • Safety and Instruction Manual • Comfort Grip • Suspension Bail (Inline models) • All Applicable Clutch Springs

**Accessories:**

Screwdriver Accessories, Screwdriver Bits and Finders see page 36



**SAFETY PRECAUTION:** Read and follow all safety and operating instructions.  
**WARNING:** Face & eye protection must be worn while operating power tools, per ANSI B186.1

Z-HANDLE SCREWDRIVERS



**Performance:**

Torque: 30 in lb (3.4 Nm) – 70 in lb (7.9 Nm)  
Speed: 1,000 rpm – 2,200 rpm

**Features:**

Lever Start  
Rear Exhaust

**Z-Handle Screwdrivers**

Model Number	Max Torque <sup>1</sup> (Soft Joint)		Free Speed	Weight		Length		Side To Center		Air Consumption		
	1/4" Quick Change	in lb		Nm	rpm	lb	kg	in	mm	in	mm	cfm
<b>Z-Handle – Stall</b>												
2S2107		70	7.9	1000	2.3	1.0	2.9	74	0.9	23	16	8
2S2207		50	5.7	1600	2.3	1.0	2.9	74	0.9	23	16	8
2S2307		36	4.1	2200	2.3	1.0	2.9	74	0.9	23	16	8
<b>Z-Handle – Low Torque Clutch<sup>1</sup></b>												
2S2103Q		60	6.8	1000	2.6	1.2	4.3	109	0.9	23	16	8
<b>Z-Handle – Mid-Torque Clutch<sup>1</sup></b>												
2S2103AQ		60	6.8	1000	2.6	1.2	4.3	109	0.9	23	16	8
2S2203AQ		46	5.2	1600	2.6	1.2	4.3	109	0.9	23	16	8
2S2303AQ		30	3.4	2200	2.6	1.2	4.3	109	0.9	23	16	8
<b>Z-Handle – Lever Start – Adjustable Clutch</b>												
2S2105Q		60	6.8	1000	2.9	1.3	5.8	147	0.9	23	16	8
2S2305Q		30	3.4	2200	2.9	1.3	5.8	147	0.9	23	16	8

<sup>1</sup> Torque output varies with force exerted by operator

**General:** Air Inlet Size: 1/4" NPT • Recommended Hose Size: 3/8" (10 mm) • Performance rated @ 90 psig (6.2 bar) air pressure

**Standard Equipment:** Parts List • Safety and Instruction Manual • Suspension Bail

**Accessories:** Screwdriver Accessories, Screwdriver Bits and Finders see page 36

RIGHT ANGLE SCREWDRIVERS

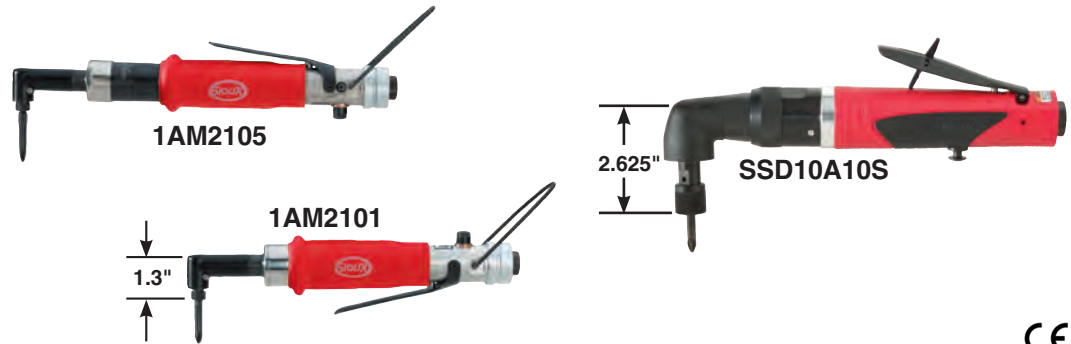

**Performance:**

Torque: 35 in lb (4 Nm) – 400 in lb (45.2 Nm)  
Speed: 300 rpm – 2,000 rpm

**Features:**

Stall Drive & Adjustable Clutch  
Button Reverse  
Lever Start  
Rear Exhaust

**Right Angle Screwdrivers**

Model Number	Max Torque (Soft Joint)		Free Speed	Weight		Length		Side To Center		Air Consumption			
	1/4" Quick Change	1/4" Internal Hex		in lb	Nm	rpm	lb	kg	in	mm	in	mm	cfm
<b>Stall Drive</b>													
	1AM2101		50	5.7	800	1.5	0.70	10.0	254	0.3	8	8	4
	1AM2201		35	4.0	1100	1.5	0.70	10.0	254	0.3	8	8	4
<b>Stall Drive</b>													
	SSD10A3S		400	45.2	300	3.4	1.50	12.0	305	0.8	20	30	14
	SSD10A5S		325	36.7	500	3.4	1.50	12.0	305	0.8	20	30	14
	SSD10A6S		220	24.9	600	3.4	1.50	12.0	305	0.8	20	30	14
	SSD10A10S		145	16.4	1000	3.4	1.50	12.0	305	0.8	20	30	14
	SSD10A16S		80	9.0	1600	3.0	1.35	11.0	280	0.8	20	30	14
	SSD10A20S		58	6.6	2000	3.0	1.35	11.0	280	0.8	20	30	14
<b>Adjustable Clutch</b>													
	1AM2105		50	5.7	800	1.9	0.90	11.8	300	0.3	8	8	4
	1AM2205		35	4.0	1100	1.9	0.90	11.8	300	0.3	8	8	4

**General:** Air Inlet Size: 1/4" NPT • Recommended Hose Size: 1/4" (6 mm) (1AM series); 3/8" (10 mm) (SSD series) • Performance rated @ 90 psig (6.2 bar) air pressure

**Standard Equipment:** Comfort Grip (1AM series)

**Accessories:** Screwdriver Accessories, Screwdriver Bits and Finders see page 36



**SAFETY PRECAUTION:** Read and follow all safety and operating instructions.  
**WARNING:** Face & eye protection must be worn while operating power tools, per ANSI B186.1



RIGHT ANGLE NUTRUNNERS



3A2104



SNR10A10S



1AM2106

**Performance:**

Torque: 50 in lb (5.7 Nm) – 600 in lb (68 Nm)  
Speed: 300 rpm – 2,000 rpm

**Features:**

Reversible  
Lever Start  
Rear and Side Exhaust

Right Angle Nutrunners



Model Number	Bolt Capacity <sup>2</sup>		Max Torque (Soft Joint)		Free Speed rpm	Weight		Length		Side To Center		Drive Size	
	in	mm	in lb	Nm		lb	kg	in	mm	in	mm	in	mm
<b>Torque Control Clutch</b>													
3A2108 <sup>1</sup>	3/8	M10	360	41	300	7.4	3.40	18.3	465	0.8	20	1/2	13
3A2208 <sup>1</sup>	3/8	M10	294	33	480	7.4	3.40	18.3	465	0.8	20	1/2	13
<b>Adjustable Clutch</b>													
1AM2106	#10	M4.5	50	5.7	800	1.9	0.90	11.6	295	0.3	8	1/4	6
<b>Stall Drive</b>													
1AM2102	#10	M4.5	50	5.7	800	1.5	0.70	11.5	292	0.3	8	1/4	6
<b>Stall Drive</b>													
3A2102 <sup>1</sup>	7/16	M11	600	68	300	6.2	2.81	17.8	452	0.8	20	1/2	13
3A2104 <sup>1</sup>	7/16	M11	600	68	300	5.5	2.50	15.5	394	0.8	20	1/2	13
<b>Stall Drive</b>													
SNR10A3S	3/8	M10	400	45.2	300	2.9	1.30	12.0	305	0.8	20	3/8	10
SNR10A5S	3/8	M10	325	36.7	500	2.9	1.30	12.0	305	0.8	20	3/8	10
SNR10A6S	3/8	M10	220	24.9	600	2.9	1.30	12.0	305	0.8	20	3/8	10
SNR10A10S	5/16	M8	145	16.4	1000	2.9	1.30	12.0	305	0.8	20	3/8	10
SNR10A16S	1/4	M6	80	9.0	1600	2.6	1.15	11.0	280	0.8	20	3/8	10
SNR10A20S	#10	M4.5	58	6.6	2000	2.6	1.15	11.0	280	0.8	20	1/4	6

<sup>1</sup> Not CE Certified

<sup>2</sup> Bolt capacities are based on suggested assembly torques applied to SAE Grade 5 and metric Class 9.8 fasteners under slightly lubricated conditions.

**General:**

Air Inlet Size: 1/4" NPT • Recommended Hose Size: 1/4" (6 mm) (1AM series); 3/8" (10 mm) (SNR, 3A series) • Performance rated @ 90 psig (6.2 bar) air pressure

**Standard Equipment:**

Parts List • Safety and Instruction Manual • Comfort Grip (1AM series) • Clutch Adjustment Wrench

**Accessories:**

Nutrunner Accessories, see page 36



**SAFETY PRECAUTION:** Read and follow all safety and operating instructions.  
**WARNING:** Face & eye protection must be worn while operating power tools, per ANSI B186.1

RATCHET WRENCHES

**Performance:**

Power: 0.3 hp (0.25 kW)  
Torque: 35 ft lb (47 Nm)

**Features:**

Lever Start  
Teasing Throttle  
Comfort Grip



SRW03S-25

**Ratchet Wrenches**

Model Number	Drive Size		Torque		Free Speed	Weight		Length		Side to Center		Air Consumption		Exhaust
	in	mm	ft lb	Nm	rpm	lb	kg	in	mm	in	mm	cfm	l/s	
<b>0.3 hp (0.25 kW)</b>														
SRW03S-25	1/4"	6	35	47	235	1.4	0.6	7.7	197	1.1	28	1.4	0.66	Rear
SRW03S-38	3/8"	10	35	47	235	1.4	0.6	7.7	197	1.1	28	1.4	0.66	Rear
SRW03S-38Q	3/8"	10	35	47	235	1.4	0.6	7.7	197	1.1	28	1.4	0.66	Rear

**General:**

Air Inlet Size: 1/4" NPT • Recommended Hose Size: 3/8" (10 mm) • Performance rated @ 90 psig (6.2 bar) air pressure

**Standard Equipment:**

Parts List • Safety and Instruction Manual • Boot for Head

**Accessories:**

Ratchet Accessories, see page 36



SRW07-38

**Performance:**

Power: 0.7 hp (0.52 kW)  
Torque: 65 ft lb (88 Nm)

**Ratchet Wrenches**

Model Number	Drive Size		Torque		Free Speed	Weight		Length		Side to Center		Air Consumption		Exhaust
	in	mm	ft lb	Nm	rpm	lb	kg	in	mm	in	mm	cfm	l/s	
<b>0.7 hp (0.52 kW)</b>														
SRW07-38	3/8"	10	65	88	260	3.0	1.3	11.8	300	1.0	25	2.7	1.27	Front
SRW07-50	1/2"	13	65	88	260	3.0	1.3	11.8	300	1.0	25	2.7	1.27	Front

**General:**

Air Inlet Size: 1/4" NPT • Recommended Hose Size: 3/8" (10 mm) • Performance rated @ 90 psig (6.2 bar) air pressure

**Standard Equipment:**

Parts List • Safety and Instruction Manual • Boot for Head

**Accessories:**

Ratchet Accessories, see page 36



**SAFETY PRECAUTION:** Read and follow all safety and operating instructions.  
**WARNING:** Face & eye protection must be worn while operating power tools, per ANSI B186.1

# ASSEMBLY

## We're Making A Big Impact

Impact wrenches are the true workhorses of industrial power tools. These incredibly powerful tools make easy work of any job in a variety of applications. Before the creation of impact tools, workers had to manually strike a hammer against a hand wrench in order to loosen or tighten nuts or bolts. They could only manage a few blows per minute. But today's impact wrenches can exert more powerful blows, and some can produce over 2000 blows per minute. This is accomplished by using the energy of compressed air and converting the motor's torque into a rapid series of powerful rotary impacts.

### Choice of Configuration

Sioux Tools offers Industrial and Force Impact Wrenches and Impact Drivers in a wide variety of configurations to meet your specific applications. In order to select the correct impact tool for your job requirements, you must take into account several factors including fastener size and grade, required torque output, and accessibility. Choosing the right mix of features such as handle configuration, type of retainer, torque output, anvil length, and drive size will make operators more productive, with less risk of discomfort and/or injury.

### Industrial Impact Tools

Built to a higher level of quality, Sioux Industrial Impact Wrenches and Impact Drivers are built a step above the standard. Manufactured from the highest quality materials, and utilizing the most advanced motor and clutch designs, these tools are constructed to hold up under continuous use in the toughest working environments.

Our extensive lineup of impact tools includes a wide selection of important features including:

- Ball & Cam or Twin Hammer impact mechanisms
- Inline, pistol grip, or D-handle configurations
- Pin, friction ring, quick change, or thru hole socket retainers
- Standard or extended anvils

In addition, Sioux offers a wide range of performance levels and characteristics to ensure a perfect match to your application. With drive sizes ranging from 1/4" (6 mm) to 1-1/2" (38 mm), and torque outputs up to 2500 ft lb (3390 Nm), finding the tool to meet your performance requirements will be simple.

### Impact Wrench Principles of Operation

An impact wrench delivers a series of rotary blows to a fastener, producing torque.

The action of the torque creates clamp force in an assembly.

Interaction of the motor, clutch and drive-end determine the type of application an impact wrench can handle.

The advantages of impact wrenches are a high power-to-weight ratio, fast rundown, and no torque reaction to operator.

### Class of Service

High production – automobile assembly plants, farm and construction equipment, etc.

Low production – large machinery assembly

Maintenance or repair work

### Job Conditions

Hard pull-up – rigid joint

Soft pull-up – spring joint

Run-down – free running, or prevailing torque (lock nut, self threading screw)

### Material

Metal-to-metal

Metal/gasket

Rubber or plastic

### Assembly Method

General tightening – operator judgement

Turn-of-the-nut – permanent assemblies (steel erection and construction equipment)

**Note:** If it takes five seconds or longer to reach final tightness, a larger wrench should be used.



IMPACT DRIVERS



IW38TBP-2Q



IW38TBP-3P

**Performance:**

Torque: 10 ft lb (13 Nm) – 70 ft lb (270 Nm)  
 Drive Size: 1/4" (6 mm) & 3/8" (10 mm)  
 Working Torque up to 70 ft-lb

**Features:**

Pistol Grip  
 Belt Clip

1/4" (6 mm) & 3/8" (10 mm) Impact Drivers



Model Number	Drive Size		Working Torque Range <sup>1</sup>		Maximum Torque		Blows Per Minute	Free Speed	Weight		Length		Side To Center		Avg Air Consumption		Socket Retainer Style
	in	mm	ft lb	Nm	ft lb	Nm			rpm	lb	kg	in	mm	in	mm	cfm	
IW38TBP-2Q	1/4	6	10-70	13-95	70	95	2000	8000	2.1	1.0	6.3	160	0.9	22	2	1	QC
IW38TBP-3P	3/8	10	10-70	13-95	70	95	2000	8000	2.1	1.0	6.3	160	0.9	22	2	1	Pin

<sup>1</sup> Maximum working torque determined by 5 second rundown on appropriate Skidmore-Wilhelm Torque-Tension Tester.

**General:**

Air Inlet Size: 1/4" NPT • Recommended Hose Size: 3/8" (10 mm) • Performance rated @ 90 psig (6.2 bar) air pressure

**Standard Equipment:**

Parts List • Safety and Instruction Manual • Suspension Bail

**Accessories:**

Impact Wrench Accessories, see page 36



ID375AP-2Q



ID375AP-2QRR



IW375AP-3P

3/8" Pinned Anvil

3/8" Friction Ring Anvil



1/4" Quick Change

**Key Features:**

High power to weight ratio  
 High impact rate of 5,000 blows per minute  
 Working torque range up to 95 ft-lb  
 Smooth Impacting that creates minimal torque reaction  
 Includes rubber boot for hammer case

**Applications:**

Wood Screws  
 Self-tapping screws  
 Lag bolts  
 High prevailing torque applications

1/4" (6 mm) & 3/8" (10 mm) Impact Drivers



Model Number	Drive Size		Working Torque Range <sup>1</sup>		Maximum Torque		Blows Per Minute	Free Speed	Weight		Length		Side To Center		Socket Retainer Style
	in	mm	ft lb	Nm	ft lb	Nm			rpm	lb	kg	in	mm	in	
ID375AP-2Q	1/4	6	10-55	13-75	60	80	5000	4000	2.5	1.1	8.5	216	0.85	21	Quick Change
ID375AP-2QRR	1/4	6	10-55	13-75	60	80	5000	4000	2.5	1.1	8.5	216	0.85	21	Quick Change
IW375AP-3P	3/8	10	10-95	13-130	100	135	5000	4000	2.5	1.1	8.5	216	0.85	21	Pin
IW375AP-3F	3/8	10	10-95	13-130	100	135	5000	4000	2.5	1.1	8.5	216	0.85	21	Ring

<sup>1</sup> Maximum working torque determined by 5 second rundown on appropriate Skidmore-Wilhelm Torque-Tension Tester.

**General:**

Air Inlet Size: 1/4" NPT • Recommended Hose Size: 3/8" (10 mm) • Performance rated @ 90 psig (6.2 bar) air pressure

**Standard Equipment:**

Parts List • Safety and Instruction Manual

**Accessories:**

Impact Wrench Accessories, see page 36



**SAFETY PRECAUTION:** Read and follow all safety and operating instructions.  
**WARNING:** Face & eye protection must be worn while operating power tools, per ANSI B186.1

## 1/2" IMPACT WRENCHES

**Performance:**

Working Torque: 100 ft lb (135 Nm) – 625 ft lb (1058 Nm)  
 Drive Size: 7/16" (11 mm) – 1/2" (13 mm)  
 Bolt Capacity: 9/16" (14 mm) – 5/8" (10 mm)

**Features:**

High power to weight ratio  
 Forged Aluminum Anvil Housing  
 One Hand Forward/Reverse Operation



### 1/2" (13mm) Impact Wrenches

Model Number	Drive Size		Bolt Cap Grade 5		Working Torque Range <sup>1</sup>		Maximum Torque		Blows Per Minute	Free Speed rpm	Weight		Length		Side To Center		Avg Air Consumption		Socket Retainer Style
	in	mm	in	mm	ft lb	Nm	ft lb	Nm			lb	kg	in	mm	in	mm	cfm	l/s	
IW500MP-4R	1/2	13	5/8	16	100-625	135-845	780	1058	1200	9400	4.2	1.9	7.0	178	1.5	38	4	2	Ring
IW500MP-4R3	1/2	13	5/8	16	100-625	135-845	780	1058	1200	9400	4.4	2.0	10.0	254	1.5	38	4	2	Ring
IW500MP-4P	1/2	13	5/8	16	100-625	135-845	780	1058	1200	9400	4.2	1.9	7.0	178	1.5	38	4	2	Pin
IW500MP-4P3	1/2	13	5/8	16	100-625	135-845	780	1058	1200	9400	4.4	2.0	10.0	254	1.5	38	4	2	Pin
IW500MP-7Q	7/16	11	9/16	14	80-500	110-675	600	810	1200	9400	4.3	2.0	7.4	188	1.5	38	4	2	QC

<sup>1</sup> Maximum working torque determined by 5 second rundown on appropriate Skidmore-Wilhelm Torque-Tension Tester.

**General:**

Air Inlet Size: 1/4" NPT • Recommended Hose Size: 3/8" (10 mm) • Performance rated @ 90 psig (6.2 bar) air pressure

**Standard Equipment:**

Parts List • Safety and Instruction Manual

**Accessories:**

Impact Wrench Accessories, see page 36

## 3/4" & 1" IMPACT WRENCHES

**Performance:**

Maximum Torque: 1,000 ft lb (1356 Nm) – 1,100 ft lb (1492 Nm)  
 Drive Size: 3/4" (19 mm) – 1" (25 mm)

**Features:**

Aluminum nose  
 Long-life Impact mechanism  
 Grease Clutch  
 Reverse biased  
 One hand Forward / Reverse operation



### Heavy Duty Impact Wrenches

Model Number	Drive Size		Bolt Cap Grade 5		Maximum Working Torque <sup>1</sup>		Maximum Torque		Blows Per Minute	Free Speed rpm	Weight		Length		Side To Center		Avg Air Consumption		Socket Retainer Style
	in	mm	in	mm	ft lb	Nm	ft lb	Nm			lb	kg	in	mm	in	mm	cfm	l/s	
IW750MP-6P	3/4	19	3/4	19	800	1085	1050	1423	1050	6700	7.5	3.44	8.5	215	N/A	N/A	5.6	2.6	Pin
IW750MP-6H	3/4	19	3/4	19	800	1085	1050	1423	1050	6700	7.5	3.44	8.5	215	N/A	N/A	5.6	2.6	Hole
IW750MP-6R	3/4	19	3/4	19	800	1085	1050	1423	1050	6700	7.5	3.44	8.5	215	N/A	N/A	5.6	2.6	Friction Ring
IW75BP-6H	3/4	19	3/4	19	800	1085	1000	1356	1000	5700	11.6	5.3	7.6	193	1.75	45	15.0	7.0	Hole
IW75BP-8H	1	25	3/4	19	825	1119	1100	1492	1000	5700	11.7	5.3	7.6	193	1.75	45	15.0	7.0	Hole

<sup>1</sup> Maximum working torque determined by 5 second rundown on appropriate Skidmore-Wilhelm Torque-Tension Tester.

**General:**

Air Inlet Size: 3/8" NPT • Recommended Hose Size: 1/2" (30 mm) • Performance rated @ 90 psig (6.2 bar) air pressure

**Standard Equipment:**

Parts List • Safety and Instruction Manual • Suspension Bail (IW75BP)

**Accessories:**

Impact Wrench Accessories, see page 36



**SAFETY PRECAUTION:** Read and follow all safety and operating instructions.  
**WARNING:** Face & eye protection must be worn while operating power tools, per ANSI B186.1

TETHERED IMPACT WRENCHES

**Performance:**

Working Torque: 100 ft lb (135 Nm) – 800 ft lb (1085 Nm)  
 Drive Size: 1/2" (13 mm) – 3/4" (19 mm)  
 Bolt Capacity: 5/8" (10 mm) – 3/4" (19 mm)

**Features:**

High power to weight ratio  
 Forged Aluminum Anvil Housing  
 One Hand Forward/Reverse Operation



1/2" (13mm) Impact Wrenches

Model Number	Drive Size		Bolt Cap Grade 5		Working Torque Range <sup>1</sup>		Maximum Torque		Blows Per Minute	Free Speed rpm	Weight		Length		Side To Center		Avg Air Consumption		Socket Retainer Style
	in	mm	in	mm	ft lb	Nm	ft lb	Nm			lb	kg	in	mm	in	mm	cfm	l/s	
IW500MP-4PT	1/2	13	5/8	16	100-625	135-845	780	1058	1200	9400	4.2	1.9	7.0	178	1.5	38	4	2	Pin
IW750MP-6PT	3/4	19	3/4	19	800	1085	1050	1423	1050	6700	7.5	3.44	8.5	215	N/A	N/A	5.6	2.6	Pin

<sup>1</sup> Maximum working torque determined by 5 second rundown on appropriate Skidmore-Wilhelm Torque-Tension Tester.

**General:** Air Inlet Size: 1/4" NPT • Recommended Hose Size: 3/8" (10 mm) • Performance rated @ 90 psig (6.2 bar) air pressure

**Standard Equipment:** Parts List • Safety and Instruction Manual

**Accessories:** Impact Wrench Accessories, see page 36



IW1000MP-8H

**Performance:**

Working Torque: 1,200 ft lb (1630 Nm) – 2,500 ft lb (3390 Nm)  
 Drive Size: 1" (25 mm) – 1-1/2" (38 mm)  
 Bolt Capacity: 1-1/4" (32 mm) – 2" (50 mm)

**Features:**

D-Handle  
 Inside and Outside Trigger  
 Steel Anvil Housing

1" (25 mm), 1-1/2" (38 mm) Impact Wrenches



IW1000MP-8H5

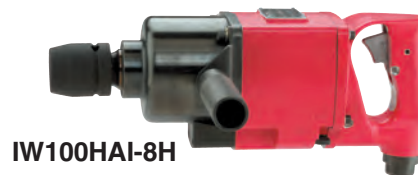

IW100HAI-8H

Model Number	Drive Size		Bolt Cap Grade 5		Maximum Working Torque <sup>1</sup>		Maximum Torque		Blows Per Minute	Free Speed rpm	Weight		Length		Side To Center		Avg Air Consumption		Socket Retainer Style
	in	mm	in	mm	ft lb	Nm	ft lb	Nm			lb	kg	in	mm	in	mm	cfm	l/s	
<b>D-Handle – Inside Trigger</b>																			
IW1000MP-8H	1	25	1-1/4	32	1200	1630	1700	2300	825	6500	18.2	8.3	14.8	376	1.85	47	34	16	Hole/Ring
IW1000MP-8H5	1	25	1-1/4	32	1200	1630	1700	2300	825	6500	19.7	8.9	19.3	490	1.85	47	34	16	Hole/Ring
IW1000MP-8H8	1	25	1-1/4	32	1200	1630	1700	2300	825	6500	20.7	9.4	22.3	556	1.85	47	34	16	Hole/Ring
IW100HAI-8H	1	25	1-3/8	35	1600	2170	2000	2710	850	5000	22.0	10.0	12.4	315	2.0	51	38	18	Hole
IW100HAI-8H6	1	25	1-3/8	35	1600	2170	2000	2710	850	5000	26.2	11.8	18.4	467	2.0	51	38	18	Hole
IW100HAI-5S	#5 Spline		1-3/8	35	1600	2170	2000	2710	850	5000	22.0	10.0	12.4	315	2.0	51	38	18	Hole
IW100HAI-5S6	#5 Spline		1-3/8	35	1600	2170	2000	2710	850	5000	26.2	11.8	18.4	467	2.0	51	38	18	Hole
IW150HAI-5S	#5 Spline		2	50	2500	3390	3000	4070	650	3750	33.0	15.0	14.5	368	2.5	65	60	28	Hole
IW150HAI-12H	1-1/2	38	2	50	2500	3390	3000	4070	650	3750	33.1	15.0	14.5	368	2.5	65	60	28	Hole
<b>D-Handle – Outside Trigger</b>																			
IW100HAO-8H	1	25	1-3/8	35	1600	2170	2000	2710	850	5000	22.0	10.0	12.4	315	2.0	51	38	18	Hole
IW100HAO-8H6	1	25	1-3/8	35	1600	2170	2000	2710	850	5000	26.2	11.8	18.4	467	2.0	51	38	18	Hole
IW100HAO-5S	#5 Spline		1-3/8	35	1600	2170	2000	2710	850	5000	22.0	10.0	12.4	315	2.0	51	38	18	Hole
IW100HAO-5S6	#5 Spline		1-3/8	35	1600	2170	2000	2710	850	5000	26.2	11.8	18.4	467	2.0	51	38	18	Hole
IW150HAO-5S	#5 Spline		2	50	2500	3390	3000	4070	650	3750	33.0	15.0	14.5	368	2.5	65	60	28	Hole
IW150HAO-12H	1-1/2	38	2	50	2500	3390	3000	4070	650	3750	33.0	15.0	14.5	368	2.5	65	60	28	Hole

<sup>1</sup> Maximum working torque determined by 5 second rundown on appropriate Skidmore-Wilhelm Torque-Tension Tester.

**General:** Air Inlet Size: 1/2" NPT • Recommended Hose Size: 1/2" (30 mm) • Performance rated @ 90 psig (6.2 bar) air pressure

**Standard Equipment:** Parts List • Safety and Instruction Manual • Support handle (D-Handle models)

**Accessories:** Impact Wrench Accessories, see page 36



**SAFETY PRECAUTION:** Read and follow all safety and operating instructions.  
**WARNING:** Face & eye protection must be worn while operating power tools, per ANSI B186.1



**Clutch Springs**



41284  
(Green)



41249B



66048  
(Silver)



66049  
(Blue)



66050  
(Green)

Part Number	Color	Torque Range	
		in lb	Nm
<b>SSD6P, SSD10P, 2S Adjustable Clutch</b>			
41284	Green	<25	<2.8
41249B	Plain	>25	>2.8
<b>1 Series Adjustable Clutch &amp; Torque Control</b>			
66048	Silver	30-50	3.4-5.7
66049	Blue	15-35	1.7-4
66050	Green	2-20	0.22-2.3

**Tether Plate Kits for Impact Wrenches\***



IW500-3



74994A

Part Number	For Use On
IW500-3	IW500MP
74994A	IW750MP

\*See Page 35 for Impacts with Pre-Installed Tether

**Comfort Grips**



66124



68340



66193

Part Number	For Use On (Drills)	For Use On (Screwdrivers)
66124	800 rpm	1 Series inline (800, 1100 & 1500 rpm)
66193	All (except 800 rpm)	1 Series inline (2200 & 2800 rpm)
68340	N/A	SSD4P Series pistol grip

**Boots**

For use on Signature series



SDR6PNBOOT / SDR10PNBOOT

For use on IW500MP models



IW500MP-BOOT

**Support Handles**



77067A

Sioux Part Number	Description
77117A	For use on 4P series screwdrivers
77067A	6P, 10P series screwdrivers



**SAFETY PRECAUTION:** Read and follow all safety and operating instructions.  
**WARNING:** Face & eye protection must be worn while operating power tools, per ANSI B186.1

# ABRASIVE



Index	
Grinders . . . . .	39 – 49
Cutoff Tools . . . . .	50
Abrasive Accessories . . . . .	51



# ABRASIVE

## Make Easy Work Out Of A Daily Grind

As manufacturing materials advance, so do the requirements for the tools to work on them. This means new speeds and attachments to handle the demands of increased precision and waste reduction.

### The right tool for the job

When selecting a grinder and accessories for your application, be sure to choose one with enough horsepower to drive the abrasive wheel you are using. This will allow the grinder's speed to work for you. When the operator bears down on an under-powered tool, it slows the rpm output and reduces overall efficiency.



### Industrial Grinders

Sioux has a great selection of inline and right angle grinders with collet sizes from 1/4" to 1/2" & 3 mm – 8 mm for a variety of applications. Speeds range up to 25,000 rpm to get the job done quickly and efficiently. Some models offer a choice of throttle control that is most convenient and comfortable for the operator. We also have extended models that fit into tight, hard to reach places.

### Abrasive Grinders Principles of Operation

When wheels, pads or other accessories are attached to the spindle, the tool can be used to remove metal or composites in a variety of ways.

### Abrasive Safety

Grinders can cause flying particles. Proper eye protection must be worn at all times by tools user and bystanders.

Under improper use and wear, Air grinders can cause serious injury and death. The following instructions are important and should be followed explicitly but cannot cover all contingencies. Good judgment is always required.

Using a grinder without a guard can cause injury. The grinder is to be operated with an appropriate guard at all times when a grinding wheel is used. Replace a damaged guard. The guard is to be the proper one for the wheel being used.

Damaged grinding wheels can explode. Check the wheel for damage before mounting, such as chips and cracks. Handle wheels carefully to avoid dropping or bumping. Protect wheels from extremes of temperature and humidity. Check wheels immediately after any unusual occurrence that may damage wheels.



Over speeding wheels can explode. Check the speed rating of the accessory or the speed printed on the wheel. This speed must be greater than the name plate speed of the grinder/sander and the actual speed of the grinder/sander as measured with a tachometer.

Unsecured work can move violently when grinding. Secure work; use clamps or vise to hold work.

Grinders may coast for a short time after the trigger is released. Be sure tool has come to a complete stop before setting it aside.

Grinding wheels that malfunction or spin off can cause injury. Be certain that all wheel, flanges, nuts and related equipment are in good shape, the proper ones for the type and size of wheel being used, and are securely fastened.

Exploding wheels can cause injury or death. If the normal sound of the grinder changes, or if it vibrates excessively, shut it off immediately, remove the wheel, and check speed with tachometer.

Unexpected starts can cause injury. Be sure actuator is off before hooking up air.

Breathing grinding dust can cause injury. Do not breathe grinding dust. Use approved mask.

Explosions and fire can cause injury. Only grind metals if the area is free of combustible or explosive materials or vapors.

Contact with rotating grinding wheels can cause injury. Keep hands and other body parts away from grinding wheels and sanding pads and disks to prevent cutting or pinching. Wear protective clothing and gloves to protect hands.

Tools starting unexpectedly can cause injury. Always remove tool from air supply and activate trigger to bleed air line before making any adjustments, changing accessories, or doing any maintenance or service on the tool.

Flying grinding wheels or accessories can cause injury. Tighten collet securely. Match wheel or accessory shaft diameter to chuck or collet.

Exploding or flying parts can cause injury. Do not use cut off wheels or router bits with die grinders.



STRAIGHT DIE GRINDERS



SDG03S25



SDG05S23



SDG7S25F



SDG10S25F

**Performance:**

Power: 0.3 hp (0.2 kW) – 1 hp (0.75 kW)  
 Speed: 12,000 rpm – 25,000 rpm  
 Collet Size: 1/4" & 6 mm

**Features:**

Lockoff Lever  
 Front or Rear Exhaust  
 Built-in Speed Control

**Straight Die Grinders**



Model Number	Free Speed	Weight		Length		Air Consumption		Collet Size	Exhaust
	rpm	lb	kg	in	mm	cfm	l/s		
<b>0.3 hp (0.22 kW) – Lever Throttle – 200 Series Collet</b>									
SDG03S25	25000	1.0	0.45	6.25	160	11	5.2	1/4"	Rear
SDG03S25M6	25000	1.0	0.45	6.25	160	11	5.2	6 mm	Rear
<b>0.3 hp (0.22 kW) – Lever Throttle – 300 Series Collet</b>									
SDG03S25S	25000	1.0	0.45	6.25	160	11	5.2	1/4"	Rear
SDG03S25M6S	25000	1.0	0.45	6.25	160	11	5.2	6mm	Rear
<b>0.5 hp (0.37 kW) – Lever Throttle – 200 Series Collet</b>									
SDG05S18	18000	1.2	0.54	7.0	180	23	10.9	1/4"	Rear
SDG05S18M6	18000	1.2	0.54	7.0	180	23	10.9	6 mm	Rear
SDG05S23	23000	1.2	0.54	7.0	180	23	10.9	1/4"	Rear
SDG05S23M6	23000	1.2	0.54	7.0	180	23	10.9	6 mm	Rear
<b>0.5 hp (0.37 kW) – Lever Throttle – 300 Series Collet</b>									
SDG05S18S	18000	1.2	0.54	7.0	180	23	10.9	1/4"	Rear
SDG05S18M6S	18000	1.2	0.54	7.0	180	23	10.9	6mm	Rear
SDG05S23S	23000	1.2	0.54	7.0	180	23	10.9	1/4"	Rear
SDG05S23M6S	23000	1.2	0.54	7.0	180	23	10.9	6mm	Rear
<b>0.7 hp (0.52 kW) – Lever Throttle – 200 Series Collet</b>									
SDG7S18F	18000	1.2	0.6	6.0	150	25	12	1/4"	Front
SDG7S18M6F	18000	1.2	0.6	6.0	150	25	12	6 mm	Front
SDG7S25F	25000	1.2	0.6	6.0	150	25	12	1/4"	Front
SDG7S25FS	25000	1.2	0.6	6.0	150	25	12	1/4"	Front
SDG7S25M6F	25000	1.2	0.6	6.0	150	25	12	6 mm	Front
<b>1 hp (0.75 kW) – Lever Throttle – 200 Series Collet</b>									
SDG10S12F	12000	1.7	0.8	7.5	190	30	14	1/4"	Front
SDG10S12M6F	12000	1.7	0.8	7.5	190	30	14	6 mm	Front
SDG10S12R	12000	1.7	0.8	7.5	190	30	14	1/4"	Rear
SDG10S12M6R	12000	1.7	0.8	7.5	190	30	14	6 mm	Rear
SDG10S18F	18000	1.7	0.8	7.5	190	30	14	1/4"	Front
SDG10S18M6F	18000	1.7	0.8	7.5	190	30	14	6 mm	Front
SDG10S18R	18000	1.7	0.8	7.5	190	30	14	1/4"	Rear
SDG10S18M6R	18000	1.7	0.8	7.5	190	30	14	6 mm	Rear
SDG10S25F	25000	1.7	0.8	7.5	190	30	14	1/4"	Front
SDG10S25M6F	25000	1.7	0.8	7.5	190	30	14	6 mm	Front
SDG10S25R	25000	1.7	0.8	7.5	190	30	14	1/4"	Rear
SDG10S25M6R	25000	1.7	0.8	7.5	190	30	14	6 mm	Rear

**General:**

Air Inlet Size: 1/4" NPT • Recommended Hose Size: 3/8" (10 mm) • Performance rated @ 90 psig (6.2 bar) air pressure

**Standard Equipment:**

Parts List • Safety and Instruction Manual • Collet & Wrenches • Collet Guard (1DS series)

**Accessories:**

Grinder Accessories, see page 51



**SAFETY PRECAUTION:** Read and follow all safety and operating instructions.  
**WARNING:** Face & eye protection must be worn while operating power tools, per ANSI B186.1

**STRAIGHT DIE GRINDERS**



**SDGS1S18**



**SDGS1S18G**

**Performance:**

Power: 1 hp (0.75 kW)  
 Speed: 12,000 rpm – 25,000 rpm  
 Collet Size: 1/4" & 6 mm

**Features:**

Lockoff Lever  
 Front Exhaust  
 Built-in Speed Control

**Straight Metal Body Die Grinders**



Model Number	Free Speed	Weight		Length		Air Consumption		Collet Size	Exhaust
	rpm	lb	kg	in	mm	cfm	l/s		
<b>1 hp (0.75 kW) – Lever Throttle – Aluminum Housing</b>									
SDGA1S12	12000	1.5	0.7	6.9	175	30	14	1/4"	Front
SDGA1S12M6	12000	1.5	0.7	6.9	175	30	14	6 mm	Front
SDGA1S18	18000	1.5	0.7	6.9	175	30	14	1/4"	Front
SDGA1S18M6	18000	1.5	0.7	6.9	175	30	14	6 mm	Front
SDGA1S25	25000	1.5	0.7	6.9	175	30	14	1/4"	Front
SDGA1S25M6	25000	1.5	0.7	6.9	175	30	14	6 mm	Front
<b>1 hp (0.75 kW) – Lever Throttle – Aluminum Housing with Grip</b>									
SDGA1S12G	12000	1.4	0.6	6.9	175	30	14	1/4"	Front
SDGA1S12M6G	12000	1.4	0.6	6.9	175	30	14	6 mm	Front
SDGA1S18G	18000	1.4	0.6	6.9	175	30	14	1/4"	Front
SDGA1S18M6G	18000	1.4	0.6	6.9	175	30	14	6 mm	Front
SDGA1S25G	25000	1.4	0.6	6.9	175	30	14	1/4"	Front
SDGA1S25M6G	25000	1.4	0.6	6.9	175	30	14	6 mm	Front
<b>1 hp (0.75 kW) – Lever Throttle – Steel Housing</b>									
SDGS1S12	12000	2.2	1.0	6.9	175	30	14	1/4"	Front
SDGS1S12M6	12000	2.2	1.0	6.9	175	30	14	6 mm	Front
SDGS1S18	18000	2.2	1.0	6.9	175	30	14	1/4"	Front
SDGS1S18M6	18000	2.2	1.0	6.9	175	30	14	6 mm	Front
SDGS1S25	25000	2.2	1.0	6.9	175	30	14	1/4"	Front
SDGS1S25M6	25000	2.2	1.0	6.9	175	30	14	6 mm	Front
<b>1 hp (0.75 kW) – Lever Throttle – Steel Housing with Grip</b>									
SDGS1S12G	12000	1.8	0.8	6.9	175	30	14	1/4"	Front
SDGS1S12M6G	12000	1.8	0.8	6.9	175	30	14	6 mm	Front
SDGS1S18G	18000	1.8	0.8	6.9	175	30	14	1/4"	Front
SDGS1S18M6G	18000	1.8	0.8	6.9	175	30	14	6 mm	Front
SDGS1S25G	25000	1.8	0.8	6.9	175	30	14	1/4"	Front
SDGS1S25M6G	25000	1.8	0.8	6.9	175	30	14	6 mm	Front

**General:**

Air Inlet Size: 1/4" NPT • Recommended Hose Size: 3/8" (10 mm) • Performance rated @ 90 psig (6.2 bar) air pressure

**Standard Equipment:**

Parts List • Safety and Instruction Manual • Collet & Wrenches

**Accessories:**

Grinder Accessories, see page 51



**SAFETY PRECAUTION:** Read and follow all safety and operating instructions.  
**WARNING:** Face & eye protection must be worn while operating power tools, per ANSI B186.1

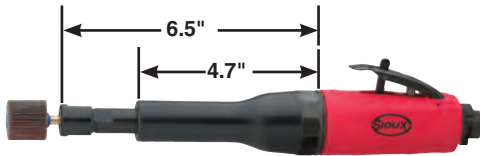

**SXG05S23**

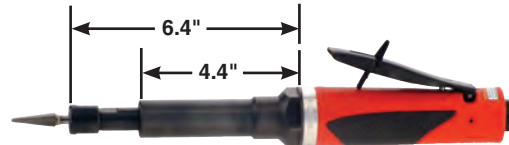

**STXG10S23**

**Performance:**

Power: 0.5 hp (0.37 kW) – 1 hp (0.75 kW)  
Speed: 12,000 rpm – 23,000 rpm  
Collet Size: 1/4" (6 mm)

**Features:**

Heavy duty double tapered collet  
Ergonomic comfort grip  
Teasing throttle for maximum control  
Lever throttle with lock-off  
Ball bearing construction  
Adjustable speed control

**Extended Die Grinders**



Model Number	Free Speed		Weight		Length		Air Consumption		Collet Size	Exhaust
	rpm		lb	kg	in	mm	cfm	l/s		
<b>0.5 hp (0.37 kW) – Lever Throttle – Extended – 200 Series Collet</b>										
SXG05S18	18000		2.1	0.95	11.0	280	23	10.9	1/4"	Rear
SXG05S18M6	18000		2.1	0.95	11.0	280	23	10.9	6 mm	Rear
SXG05S23	23000		2.1	0.95	11.0	280	23	10.9	1/4"	Rear
SXG05S23M6	23000		2.1	0.95	11.0	280	23	10.9	6 mm	Rear
<b>0.5 hp (0.37 kW) – Extended Die Grinder Lever Throttle – 300 Series Collet</b>										
SXG05S18S	18000		2.1	0.95	11.0	280	23	10.9	1/4"	Rear
SXG05S18M6S	18000		2.1	0.95	11.0	280	23	10.9	6mm	Rear
SXG05S23S	23000		2.1	0.95	11.0	280	23	10.9	1/4"	Rear
SXG05S23M6S	23000		2.1	0.95	11.0	280	23	10.9	6mm	Rear
<b>1 hp (0.75 kW) – Lever Throttle – Extended – 200 Series Collet</b>										
STXG10S12	12000		2.2	1.0	12.1	308	30	14	1/4"	Rear
STXG10S12M6	12000		2.2	1.0	12.1	308	30	14	6 mm	Rear
STXG10S18	18000		2.2	1.0	12.1	308	30	14	1/4"	Rear
STXG10S18M6	18000		2.2	1.0	12.1	308	30	14	6 mm	Rear
STXG10S23	23000		2.2	1.0	12.1	308	30	14	1/4"	Rear
STXG10S23M6	23000		2.2	1.0	12.1	308	30	14	6 mm	Rear
<b>1 hp (0.75 kW) – Lever Throttle – Extended – Cone Wheel</b>										
STXG10S18CW	18000		2.2	1.0	12.2	310	30	14	3/8"-24 EXT Thread	Rear

**General:**

Air Inlet Size: 1/4" NPT • Recommended Hose Size: 3/8" (10 mm) • Performance rated @ 90 psig (6.2 bar) air pressure

**Standard Equipment:**

Parts List • Safety and Instruction Manual • Collet & Wrenches

**Accessories:**

Grinder Accessories, see page 51



**SAFETY PRECAUTION:** Read and follow all safety and operating instructions.  
**WARNING:** Face & eye protection must be worn while operating power tools, per ANSI B186.1

**HIGH TORQUE DIE GRINDERS**

Double Ball Bearing Support On Output Spindle

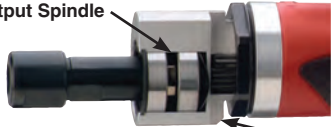

Offset Gear Box For Increased Torque



**SDG10SHT08**



**SDG10SHT12**

**High Torque Die Grinders**



Model Number	Free Speed	Weight		Length		Air Consumption		Collet Size	Exhaust
	rpm	lb	kg	in	mm	cfm	l/s		
<b>1 hp (0.75 kW) – Lever Throttle – High Torque</b>									
SDG10SHT08	8000	2.0	0.90	9.5	240	35	16.5	1/4"	Rear
SDG10SHT08M6	8000	2.0	0.90	9.5	240	35	16.5	6 mm	Rear
SDG10SHT12	12000	2.0	0.90	9.5	240	35	16.5	1/4"	Rear
SDG10SHT12M6	12000	2.0	0.90	9.5	240	35	16.5	6 mm	Rear

**General:**

Air Inlet Size: 1/4" NPT • Recommended Hose Size: 3/8" (10 mm) • Performance rated @ 90 psig (6.2 bar) air pressure

**Standard Equipment:**

Parts List • Safety and Instruction Manual • Collet & Wrenches

**Accessories:**

Grinder Accessories, see page 51

**STRAIGHT DIE GRINDERS**



**RT1985**

**Performance:**

Power: 1.5 hp (1.1 kW)  
 Speed: 20,000 rpm  
 Collet Size: 1/4" – 1/2" & 6 mm

**Features:**

Twist Throttle  
 Side Exhaust  
 Built-in Speed Control

**Straight Die Grinders**



Model Number	Free Speed	Weight		Length		Air Consumption		Collet Size	Exhaust
	rpm	lb	kg	in	mm	cfm	l/s		
<b>1.5 hp (1.1 kW) – Twist Throttle</b>									
RT1985 <sup>1</sup>	20000	4.3	2.0	7.6	193	38	18	1/4"	Side
1985-1/2	20000	4.3	2.0	7.6	193	38	18	1/2"	Side
1985A	20000	4.3	2.0	7.6	193	38	18	3/8"	Side

<sup>1</sup>Not CE Certified

**General:**

Air Inlet Size: 1/4" NPT • Recommended Hose Size: 3/8" (10 mm) • Performance rated @ 90 psig (6.2 bar) air pressure

**Standard Equipment:**

Parts List • Safety and Instruction Manual • Collet & Wrenches • Collet Guard (1DS series)

**Accessories:**

Grinder Accessories, see page 51





RIGHT ANGLE DIE GRINDERS



**Performance:**

Power: 0.3 hp (0.22 kW) – 1 hp (0.75 kW)  
 Speed: 12,000 rpm – 23,000 rpm  
 Collet Size: 1/4" & 6 mm

**Features:**

Lockoff Lever  
 Built-in Speed Control

**Right Angle Die Grinders**



Model Number	Free Speed	Weight		Length		Air Consumption		Collet Size	Exhaust
	rpm	lb	kg	in	mm	cfm	l/s		
<b>0.3 hp (0.22 kW) – Lever Throttle – 200 Series Collet</b>									
SAG03S12	12000	1.2	0.55	5.6	140	11	5.2	1/4"	Rear
SAG03S12M6	12000	1.2	0.55	5.6	140	11	5.2	6 mm	Rear
SAG03S20	20000	1.2	0.55	5.6	140	11	5.2	1/4"	Rear
SAG03S20M6	20000	1.2	0.55	5.6	140	11	5.2	6 mm	Rear
<b>0.3 hp (0.22 kW) – Lever Throttle – 300 Series Collet</b>									
SAG03S12S	12000	1.15	0.52	5.6	143	11	5.2	1/4"	Rear
SAG03S12M6S	12000	1.15	0.52	5.6	143	11	5.2	6mm	Rear
SAG03S20S	20000	1.15	0.52	5.6	143	11	5.2	1/4"	Rear
SAG03S20M6S	20000	1.15	0.52	5.6	143	11	5.2	6mm	Rear
<b>0.5 hp (0.37 kW) – Lever Throttle – 200 Series Collet</b>									
SAG05S12	12000	1.7	0.77	6.9	175	23	11	1/4"	Rear
SAG05S12M6	12000	1.7	0.77	6.9	175	23	11	6 mm	Rear
SAG05S15	15000	1.7	0.77	6.9	175	23	11	1/4"	Rear
SAG05S15M6	15000	1.7	0.77	6.9	175	23	11	6mm	Rear
SAG05S18	18000	1.7	0.77	6.9	175	23	11	1/4"	Rear
SAG05S18M6	18000	1.7	0.77	6.9	175	23	11	6mm	Rear
SAG05S23	23000	1.4	0.64	6.4	160	23	10.8	1/4"	Rear
SAG05S23M6	23000	1.4	0.64	6.4	160	23	10.8	6 mm	Rear
<b>0.5 hp (0.37 kW) – Lever Throttle – 300 Series Collet</b>									
SAG05S12S	12000	1.7	0.77	6.9	175	23	11	1/4"	Rear
SAG05S12M6S	12000	1.7	0.77	6.9	175	23	11	6 mm	Rear
SAG05S15S	15000	1.7	0.77	6.9	175	23	11	1/4"	Rear
SAG05S15M6S	15000	1.7	0.77	6.9	175	23	11	6mm	Rear
SAG05S18S	18000	1.7	0.77	6.9	175	23	11	1/4"	Rear
SAG05S18M6S	18000	1.7	0.77	6.9	175	23	11	6mm	Rear
SAG05S23S	23000	1.35	0.61	6.4	162	23	10.8	1/4"	Rear
SAG05S23M6S	23000	1.35	0.61	6.4	162	23	10.8	6mm	Rear
<b>0.70 hp (0.52 kW) – Lever Throttle – 200 Series Collet</b>									
SAG7S12	12000	2.0	0.90	6.5	165	25	12	1/4"	Front
SAG7S12M6	12000	2.0	0.90	6.5	165	25	12	6mm	Front
SAG7S15	15000	2.0	0.90	6.5	165	25	12	1/4"	Front
SAG7S15M6	15000	2.0	0.90	6.5	165	25	12	6mm	Front
SAG7S18	18000	2.0	0.90	6.5	165	25	12	1/4"	Front
SAG7S18M6	18000	2.0	0.90	6.5	165	25	12	6mm	Front
<b>1 hp (0.75 kW) – Lever Throttle – 200 Series Collet</b>									
SAG10S12	12000	2.7	1.2	9.0	230	30	14	1/4"	Rear
SAG10S12M6	12000	2.7	1.2	9.0	230	30	14	6 mm	Rear
SAG10S15	15000	2.7	1.2	9.0	230	30	14	1/4"	Rear
SAG10S15M6	15000	2.7	1.2	9.0	230	30	14	6 mm	Rear
SAG10S18	18000	2.7	1.2	9.0	230	30	14	1/4"	Rear
SAG10S18M6	18000	2.7	1.2	9.0	230	30	14	6 mm	Rear

**General:** Air Inlet Size: 1/4" NPT • Recommended Hose Size: 3/8" (10 mm) • Performance rated @ 90 psig (6.2 bar) air pressure

**Standard Equipment:** Parts List • Safety and Instruction Manual • Collet, Support Handle (1 HP only) & Wrenches

**Accessories:** Grinder Accessories, see page 51



**SAFETY PRECAUTION:** Read and follow all safety and operating instructions.

**WARNING:** Face & eye protection must be worn while operating power tools, per ANSI B186.1

**RIGHT ANGLE EXTENDED DIE GRINDERS**

**Performance:**

Power: 0.7 hp (0.52 kW) – 1 hp (0.75 kW)  
 Speed: 12,000 rpm – 20,000 rpm  
 Collet Size: 1/4" & 6 mm

**Features:**

Heavy duty double tapered collet  
 Teasing throttle  
 Lock-off lever  
 Heavy Duty spiral bevel gearing for durability and smooth operation  
 Compact angle head allows access into tight spaces  
 Adjustable speed control  
 Grease zerk in gear case



**Right Angle Extended Die Grinders**



Model Number	Free Speed	Weight		Length		Air Consumption		Collet Size	Exhaust
	rpm	lb	kg	in	mm	cfm	l/s		
<b>1 hp (0.75 kW) – Lever Throttle – 200 Series Collet</b>									
SAG10AX12	12000	3.20	1.45	11.25	286	30	14.2	1/4"	Rear
SAG10AX12M6	12000	3.20	1.45	11.25	286	30	14.2	6mm	Rear
SAG10AX15	15000	3.20	1.45	11.25	286	30	14.2	1/4"	Rear
SAG10AX15M6	15000	3.20	1.45	11.25	286	30	14.2	6mm	Rear
SAG10AX18	18000	3.20	1.45	11.25	286	30	14.2	1/4"	Rear
SAG10AX18M6	18000	3.20	1.45	11.25	286	30	14.2	6mm	Rear
<b>0.7 hp (0.52 kW) – Lever Throttle</b>									
SAG7AX13	13000	2.9	1.3	10.0	254	25	12	1/4"	Front
SAG7AX13M6	13000	2.9	1.3	10.0	254	25	12	6 mm	Front
SAG7AX16	16000	2.9	1.3	10.0	254	25	12	1/4"	Front
SAG7AX16M6	16000	2.9	1.3	10.0	254	25	12	6 mm	Front
SAG7AX20	20000	2.9	1.3	10.0	254	25	12	1/4"	Front
SAG7AX20M6	20000	2.9	1.3	10.0	254	25	12	6 mm	Front

**General:**

Air Inlet Size: 1/4" NPT • Recommended Hose Size: 3/8" (10 mm) • Performance rated @ 90 psig (6.2 bar) air pressure

**Standard Equipment:**

Parts List • Safety and Instruction Manual • Collet, Support Handle (1 HP only) & Wrenches

**Accessories:**

Grinder Accessories, see page 51

**Sioux Swivel**

Part Number	Description
1338-25	1/4" non-regulated air swivel connector with safety pin
1338-38	3/8" non-regulated air swivel connector with safety pin
1338-50	1/2" non-regulated air swivel connector with safety pin
1338FC-25	1/4" regulated air swivel connector with safety pin

Allows the air hose to rotate 360° on 2 axes.



1338-25



1338FC-25



**SAFETY PRECAUTION:** Read and follow all safety and operating instructions.  
**WARNING:** Face & eye protection must be worn while operating power tools, per ANSI B186.1



**SAGA1AX12G**



**SAGA1AX12**

**Performance:**

Power: 1 hp (0.75 kW)  
Speed: 12,000 rpm – 18,000 rpm  
Collet Size: 1/4" & 6 mm

**Features:**

Lockoff Lever  
Robust Steel or Durable Aluminum Housing  
Available With Comfort Grip

**Right Angle Extended Metal Body Die Grinders**



Model Number	Free Speed	Weight		Length		Air Consumption		Collet Size	Exhaust
	rpm	lb	kg	in	mm	cfm	l/s		
<b>1 hp (0.75 kW) – Lever Throttle – Aluminum Housing</b>									
SAGA1AX12	12000	3.2	1.5	10.5	267	30	14.2	1/4"	Front
SAGA1AX12M6	12000	3.2	1.5	10.5	267	30	14.2	6mm	Front
SAGA1AX15	15000	3.2	1.5	10.5	267	30	14.2	1/4"	Front
SAGA1AX15M6	15000	3.2	1.5	10.5	267	30	14.2	6mm	Front
SAGA1AX18	18000	3.2	1.5	10.5	267	30	14.2	1/4"	Front
SAGA1AX18M6	18000	3.2	1.5	10.5	267	30	14.2	6mm	Front
<b>1 hp (0.75 kW) – Lever Throttle – Aluminum Housing with Grip</b>									
SAGA1AX12G	12000	2.9	1.3	10.5	267	30	14.2	1/4"	Front
SAGA1AX12M6G	12000	2.9	1.3	10.5	267	30	14.2	6mm	Front
SAGA1AX15G	15000	2.9	1.3	10.5	267	30	14.2	1/4"	Front
SAGA1AX15M6G	15000	2.9	1.3	10.5	267	30	14.2	6mm	Front
SAGA1AX18G	18000	2.9	1.3	10.5	267	30	14.2	1/4"	Front
SAGA1AX18M6G	18000	2.9	1.3	10.5	267	30	14.2	6mm	Front
<b>1 hp (0.75 kW) – Lever Throttle – Steel Housing</b>									
SAGS1AX12	12000	3.8	1.7	10.5	267	30	14.2	1/4"	Front
SAGS1AX12M6	12000	3.8	1.7	10.5	267	30	14.2	6mm	Front
SAGS1AX15	15000	3.8	1.7	10.5	267	30	14.2	1/4"	Front
SAGS1AX15M6	15000	3.8	1.7	10.5	267	30	14.2	6mm	Front
SAGS1AX18	18000	3.8	1.7	10.5	267	30	14.2	1/4"	Front
SAGS1AX18M6	18000	3.8	1.7	10.5	267	30	14.2	6mm	Front
<b>1 hp (0.75 kW) – Lever Throttle – Steel Housing with Grip</b>									
SAGS1AX12G	12000	3.4	1.5	10.5	267	30	14.2	1/4"	Front
SAGS1AX12M6G	12000	3.4	1.5	10.5	267	30	14.2	6mm	Front
SAGS1AX15G	15000	3.4	1.5	10.5	267	30	14.2	1/4"	Front
SAGS1AX15M6G	15000	3.4	1.5	10.5	267	30	14.2	6mm	Front
SAGS1AX18G	18000	3.4	1.5	10.5	267	30	14.2	1/4"	Front
SAGS1AX18M6G	18000	3.4	1.5	10.5	267	30	14.2	6mm	Front

**General:**

Air Inlet Size: 1/4" NPT • Recommended Hose Size: 3/8" (10 mm) • Performance rated @ 90 psig (6.2 bar) air pressure

**Standard Equipment:**

Parts List • Safety and Instruction Manual • Collet, Support Handle & Wrenches

**Accessories:**

Grinder Accessories, see page 51



**SAFETY PRECAUTION:** Read and follow all safety and operating instructions.  
**WARNING:** Face & eye protection must be worn while operating power tools, per ANSI B186.1

**RIGHT ANGLE TYPE 27 WHEEL GRINDERS**

**Performance:**

Power: 0.7 hp (0.52 kW) – 1 hp (0.75 kW)  
 Speed: 12,000 rpm – 20,000 rpm  
 Wheel Capacity: 3" (75 mm) – 5" (127 mm)

**Features:**

Non-Governed  
 Lockoff Lever  
 Adjustable Guard



**Right Angle Type 27 Extended Wheel Grinders**



Model Number	Free Speed	Wheel Capacity		Weight		Length		Air Consumption Free Speed		Spindle Thread	Exhaust
	rpm	In	mm	lb	kg	in	mm	cfm	l/s		
<b>1 hp (0.75 kW) – Lockoff Lever Throttle</b>											
SWG10AX124	12000	4.0	100	3.6	1.63	11.25	285	35	17	3/8" - 24	Rear
SWG10AXL124	12000	4.0	100	3.5	1.59	11.25	285	35	17	3/8" - 24	Rear
SWG10AX1245	12000	4.5	115	3.7	1.68	11.25	285	35	17	5/8" - 11	Rear
SWG10AX125	12000	5.0	125	3.8	1.72	11.25	285	35	17	5/8" - 11	Rear
<b>0.7 hp (0.52 kW) – Lever Throttle</b>											
SWG7AX134	13300	4.0	100	3.5	1.6	10.0	254	25	12	3/8" - 24	Front
SWG7AX1345	13300	4.5	115	3.5	1.6	10.0	254	25	12	5/8" - 11	Front
SWG7AX203	20000	3.0	75	3.5	1.6	10.0	254	25	12	3/8" - 24	Front

**General:**

**1 HP models:** Air Inlet Size: 3/8" NPT • Recommended Hose Size: 3/8" (10 mm) • Performance rated @ 90 psig (6.2 bar) air pressure  
**0.7 HP models:** Air Inlet Size: 1/4" NPT • Recommended Hose Size: 3/8" (10 mm) • Performance rated @ 90 psig (6.2 bar) air pressure

**Standard Equipment:**

Parts List • Safety and Instruction Manual • Spindle Wrenches • Wheel Guard • Support Handle • Mounting Flange & Nut • Grinding Wheel

**Accessories:**

Grinder Accessories, see page 51



**Performance:**

Power: 1 hp (0.75 kW)  
 Speed: 12,000 rpm  
 Wheel Capacity: 4" (100 mm) – 4.5" (115 mm)

**Features:**

Non-Governed  
 Lockoff Lever  
 Adjustable Guard  
 Robust Steel or Durable Aluminum Housing  
 Available With Comfort Grip  
 Head Height 2.28"

**Right Angle Type 27 Extended Wheel Grinders**



Model Number	Free Speed	Wheel Capacity		Weight		Length		Air Consumption Free Speed		Spindle Thread	Exhaust
	rpm	In	mm	lb	kg	in	mm	cfm	l/s		
<b>1 hp (0.75 kW) – Lever Throttle – Aluminum Housing</b>											
SWGA1AX124	12000	4.0	100	3.3	1.5	10.5	267	35	17	3/8" - 24	Front
SWGA1AX1245	12000	4.5	115	3.4	1.5	10.5	267	35	17	5/8" - 11	Front
<b>1 hp (0.75 kW) – Lever Throttle – Aluminum Housing with Grip</b>											
SWGA1AX124G	12000	4.0	100	3.2	1.5	10.5	267	35	17	3/8" - 24	Front
SWGA1AX1245G	12000	4.5	115	3.3	1.5	10.5	267	35	17	5/8" - 11	Front
<b>1 hp (0.75 kW) – Lever Throttle – Steel Housing</b>											
SWGS1AX124	12000	4.0	100	3.9	1.8	10.5	267	35	17	3/8" - 24	Front
SWGS1AX1245	12000	4.5	115	4.0	1.8	10.5	267	35	17	5/8" - 11	Front
<b>1 hp (0.75 kW) – Lever Throttle – Steel Housing with Grip</b>											
SWGS1AX124G	12000	4.0	100	3.7	1.7	10.5	267	35	17	3/8" - 24	Front
SWGS1AX1245G	12000	4.5	115	3.8	1.7	10.5	267	35	17	5/8" - 11	Front

**General:**

**1 HP models:** Air Inlet Size: 3/8" NPT • Recommended Hose Size: 3/8" (10 mm) • Performance rated @ 90 psig (6.2 bar) air pressure

**Standard Equipment:**

Parts List • Safety and Instruction Manual • Spindle Wrenches • Wheel Guard • Support Handle • Mounting Flange & Nut • Grinding Wheel

**Accessories:**

Grinder Accessories, see page 51



**SAFETY PRECAUTION:** Read and follow all safety and operating instructions.  
**WARNING:** Face & eye protection must be worn while operating power tools, per ANSI B186.1



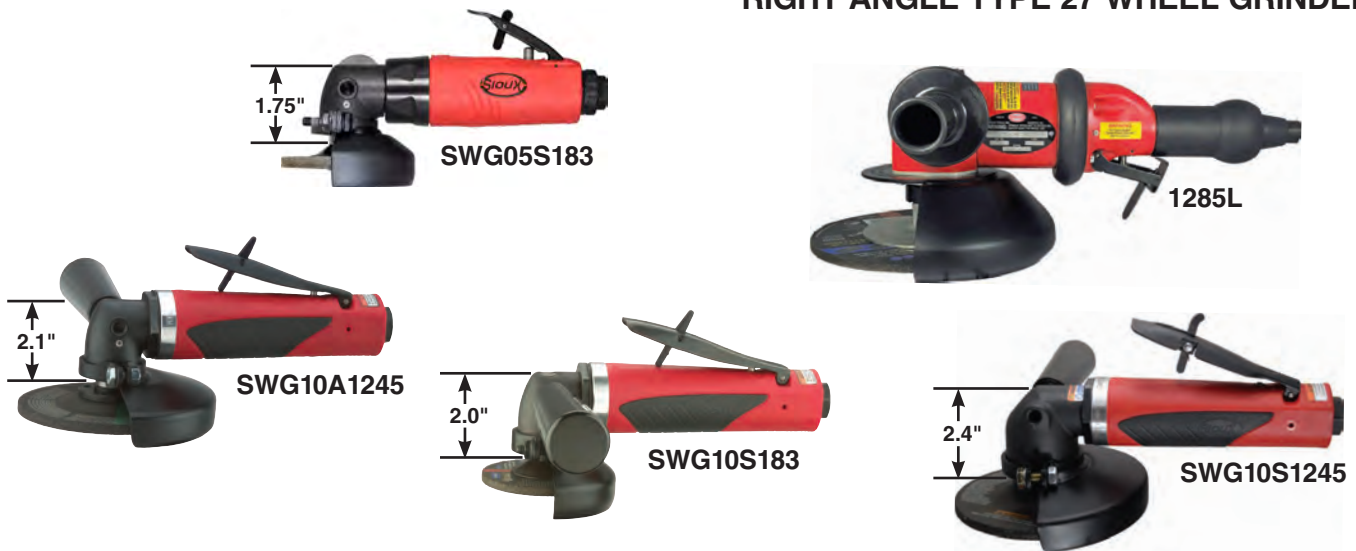

**Performance:**

Power: 0.5 hp (0.37 kW) – 1 hp (0.75 kW)  
 Speed: 6,000 rpm – 18,000 rpm  
 Wheel Capacity: 3" (75 mm) – 7" (175 mm) diameter

**Features:**

Governed & Non-Governed  
 Lockoff Lever Throttle  
 Side Exhaust: 1285L  
 Rear Exhaust: SWG Series

**Right Angle Type 27 Wheel Grinders**



Model Number	Free Speed		Wheel Capacity		Weight		Length		Air Consumption Under Load		Air Consumption Free Speed		Spindle Thread
	rpm		in	mm	lb	kg	in	mm	cfm	l/s	cfm	l/s	
<b>0.5 hp (0.37 kW)</b>													
SWG05S183	18000		3.0	75	2.0	0.91	7.0	178	N/A	N/A	23	11	3/8"-24
<b>0.7 hp (0.52 kW)</b>													
SWG7S183	18000		3.0	75	2.1	0.95	6.4	163	N/A	N/A	25	12	3/8"-24
<b>1 hp (0.75 kW) – Medium Duty Angle Head</b>													
SWG10A124	12000		4.0	100	2.5	1.1	7.75	195	N/A	N/A	35	17	3/8" - 24
SWG10A1245	12000		4.5	115	2.6	1.17	7.75	195	N/A	N/A	35	17	5/8"-11
SWG10A125	12000		5.0	125	2.7	1.22	7.75	195	N/A	N/A	35	17	5/8" - 11
SWG10S183	18000		3.0	75	2.5	1.1	7.5	190	N/A	N/A	35	17	3/8"-24
<b>1 hp (0.75 kW) – Heavy Duty Angle Head</b>													
SWG10S124	12000		4.0	100	3.3	1.5	8.3	210	N/A	N/A	35	17	3/8"-24
SWG10S1245	12000		4.5	115	3.3	1.5	8.3	210	N/A	N/A	35	17	5/8"-11
SWG10S125	12000		5.0	125	3.4	1.5	8.3	210	N/A	N/A	35	17	5/8"-11
SWG10S106	10000		6.0	150	3.7	1.7	8.3	210	N/A	N/A	35	17	5/8"-11
<b>1 hp (0.75 kW) – Governed Speed – Lockoff Lever Throttle</b>													
1285L <sup>1</sup>	6000		7.0	180	5.9	2.7	12.4	315	35	17	18	8	5/8"-11

<sup>1</sup>Not CE Certified

**General:**

Air Inlet Size: 1/4" NPT • Recommended Hose Size: 3/8" (10 mm) • Performance rated @ 90 psig (6.2 bar) air pressure

**Standard Equipment:**

Parts List • Safety and Instruction Manual • Spindle Wrenches • Wheel Guard • Support Handle • Mounting Flange & Nut • Grinding Wheel

**Accessories:**

Grinder Accessories, see page 51



**SAFETY PRECAUTION:** Read and follow all safety and operating instructions.  
**WARNING:** Face & eye protection must be worn while operating power tools, per ANSI B186.1

**VERTICAL TYPE 27 WHEEL GRINDERS**

**Performance:**

Power: 1 hp (0.75 kW) – 3 hp (2.2 kW)  
 Speed: 4,500 rpm – 6,000 rpm  
 Wheel Capacity: 7" (175 mm) – 9" (230 mm) diameter

**Features:**

Governed & Non-Governed  
 Lockoff Lever & Thumb Throttle  
 Side Exhaust



**Vertical Type 27 Wheel Grinders**

Model Number	Free Speed		Wheel Capacity		Weight		Length		Air Consumption Under Load		Air Consumption Free Speed		Spindle Thread
	rpm		in	mm	lb	kg	in	mm	cfm	l/s	cfm	l/s	
<b>1 hp (0.75 kW) – Non-Governer Speed – Thumb Throttle</b>													
1291L	6000		7.0	175	5.0	2.3	7.2	183	30	14	38	18	5/8"-11
<b>1 hp (0.75 kW) – Non-Governer Speed – Thumb Throttle</b>													
1291	6000		7.0	175	5.0	2.3	7.2	183	30	14	38	18	5/8"-11
<b>2 hp (1.5 kW) – Class Vertical Grinders – Governed Speed – Lever Throttle</b>													
VG20AL-45D9	4500		9.0	230	7.4	3.3	5.5	145	75	35	26	12	5/8"-11
VG20AL-60D7	6000		7.0	175	7.4	3.3	5.5	145	75	35	26	12	5/8"-11
VG20AL-60D9	6000		9.0	230	7.4	3.3	5.5	145	75	35	26	12	5/8"-11
<b>3 hp (2.2 kW) – Class Vertical Grinders – Governed Speed – Lever Throttle</b>													
VG30AL-45D7	4500		7.0	175	9.5	4.3	6.4	165	90	42	39	18	5/8"-11
VG30AL-45D9	4500		9.0	230	9.5	4.3	6.4	165	90	42	39	18	5/8"-11
VG30AL-60D7	6000		7.0	175	9.5	4.3	6.4	165	90	42	39	18	5/8"-11
VG30AL-60D9	6000		9.0	230	9.5	4.3	6.4	165	90	42	39	18	5/8"-11

**General:**

Air Inlet Size: 1/4" NPT (1290 series); 1/2" NPT (V series) • Recommended Hose Size: 3/8" (10 mm) (1290 series); 1/2" (13 mm) (V series)  
 Performance rated @ 90 psig (6.2 bar) air pressure

**Standard Equipment:**

Parts List • Safety and Instruction Manual • Spindle Wrenches • Wheel Guard • Mounting Flange & Nut • Grinding Wheel (1291 & 1291L)

**Accessories:**

Grinder Accessories, see page 51

**VERTICAL TYPE 6 & 11 WHEEL GRINDERS**

**Performance:**

Power: 2 hp (1.5 kW) – 3 hp (2.2 kW)  
 Speed: 6,000 rpm  
 Wheel Capacity: 6" (150 mm)

**Features:**

Governed Speed  
 Lockoff Lever  
 Side Exhaust



**Vertical Type 6 & 11 Wheel Grinders**

Model Number	Free Speed		Wheel Capacity		Weight		Length		Air Consumption Under Load		Air Consumption Free Speed		Spindle Thread
	rpm		in	mm	lb	kg	in	mm	cfm	l/s	cfm	l/s	
<b>2 hp (1.5 kW) – Class Vertical Grinders – Governed Speed – Lever Throttle</b>													
VG20AL-60C6	6000		6.0	150	7.4	3.3	5.5	145	75	35	26	12	5/8"-11
<b>3 hp (2.2 kW) – Class Vertical Grinders – Governed Speed – Lever Throttle</b>													
VG30AL-60C6	6000		6.0	150	9.5	4.3	6.4	165	90	42	39	18	5/8"-11

**General:**

Air Inlet Size: 1/2" NPT • Recommended Hose Size: 1/2" (13 mm) • Performance rated @ 90 psig (6.2 bar) air pressure

**Standard Equipment:**

Parts List • Safety and Instruction Manual • Spindle Wrenches • Wheel Guard • Mounting Flange & Nut

**Accessories:**

Grinder Accessories, see page 51



**SAFETY PRECAUTION:** Read and follow all safety and operating instructions.  
**WARNING:** Face & eye protection must be worn while operating power tools, per ANSI B186.1

**HORIZONTAL GRINDERS**

**Performance:**

Power: 2 hp (1.5 kW) – 3 hp (2.2 kW)  
 Speed: 4,500 rpm – 8,000 rpm  
 Wheel Capacity: 3" (75 mm) – 8" (200 mm)

**Features:**

Governed Speed  
 Lever Throttle  
 Side Exhaust



**HG30AL-60S6**



**HG20AL-80P3**



**Horizontal Wheel Grinders**

Model Number	Free Speed		Wheel Capacity		Weight		Length		Air Consumption Under Load		Air Consumption Free Speed		Spindle Thread
	rpm		in	mm	lb	kg	in	mm	cfm	l/s	cfm	l/s	
<b>2 hp (1.5 kW) – Class Horizontal Grinders – Governed Speed – Lever Throttle</b>													
HG20AL-45S8	4500		8.0	200	10.5	4.8	20.8	530	75	35	26	12	5/8"-11
HG20AL-60S6	6000		6.0	150	10.5	4.8	20.8	530	75	35	26	12	5/8"-11
HG20AL-80P3	8000		3.0	75	10.5	4.8	20.8	530	75	35	26	12	5/8"-11
<b>3 hp (2.2 kW) – Class Horizontal Grinders – Governed Speed – Lever Throttle</b>													
HG30AL-45S8	4500		8.0	200	12.5	5.6	21.8	550	90	42	39	18	5/8"-11
HG30AL-60S6	6000		6.0	150	12.5	5.6	21.8	550	90	42	39	18	5/8"-11
HG30AL-80P3	8000		3.0	75	12.5	5.6	21.8	550	90	42	39	18	5/8"-11

**General:** Air Inlet Size: 1/2" NPT • Recommended Hose Size: 1/2" (13 mm) • Performance rated @ 90 psig (6.2 bar) air pressure  
**Standard Equipment:** Parts List • Safety and Instruction Manual • Spindle Wrenches • Wheel Guard • Mounting Flange & Nut  
**Accessories:** Grinder Accessories, see page 51

**MATERIAL REMOVAL TOOL**

**Performance:**

Power: 0.5 hp (0.37 kW)  
 Speed: 3,500 rpm

**Features:**

Removable Support Handle  
 Lockoff Lever  
 Planetary Gear for Increased Torque



**SMR05S354**



**Material Removal Tool**

Model Number	Free Speed		Weight		Length		Air Consumption		Exhaust
	rpm		lb	kg	in	mm	cfm	l/s	
SMR05S354	3500		2.4	1.08	12.0	304.8	28	132	Rear

**General:** Air Inlet Size: 1/4" NPT • Recommended Hose Size: 3/8" (10 mm) • Performance rated @ 90 psig (6.2 bar) air pressure  
**Standard Equipment:** Parts List • Safety and Instruction Manual • Fine Belt (68813) • Coarse Belt (68814) • Eraser (68815) • Support Handle

**BELTS AND ERASERS**



**Hub Set 68918**



**Eraser 68815**



**Course Wire Belt 68814**



**Fine Wire Belt 68813**



**Medium Stainless Steel Wire Belt 68917**



**Fine Stainless Steel Wire Belt 68915**

Part Number	Description
68918	11mm Hub Set
68815	Rubber Eraser
68814	Course Wire Belt, 23 mm Wide
68910	Course Wire Belt, 11 mm Wide
68911	Medium Wire Belt, 23 mm Wide
68912	Medium Wire Belt, 11 mm Wide
68813	Fine Wire Belt, 23 mm Wide
68913	Fine Wire Belt, 11 mm Wide
68916	Medium Stainless Steel Wire Belt, 23 mm Wide
68917	Medium Stainless Steel Wire Belt, 11 mm Wide
68914	Fine Stainless Steel Wire Belt, 23 mm Wide
68915	Fine Stainless Steel Wire Belt, 11 mm Wide



**WARNING**



**SAFETY PRECAUTION:** Read and follow all safety and operating instructions.  
**WARNING:** Face & eye protection must be worn while operating power tools, per ANSI B186.1

CUTOFF TOOLS (TYPE 1)

Performance:

Power: 1 hp (0.75 kW)  
Free Speed: 18,000 rpm – 25,000 rpm

Features:

Inline  
Lockoff Lever Start  
Front or Rear Exhaust



SCO10S253F



Cutoff Tool

Model Number	Blade Diameter		Depth of Cut		Free Speed rpm	Weight		Length		Air Consumption		Exhaust
	in	mm	in	mm		lb	kg	in	mm	cfm	l/s	
<b>1 hp (0.75 kW) – Cutoff Tool – Inline – Lockoff lever Start</b>												
SCO10S184F	4.0	100	1.1	28	18000	2.0	0.9	8.3	210	30	14	Front
SCO10S184R	4.0	100	1.1	28	18000	2.0	0.9	8.3	210	30	14	Rear
SCO10S204F	4.0	100	1.1	28	20000	2.0	0.9	8.3	210	30	14	Front
SCO10S204R	4.0	100	1.1	28	20000	2.0	0.9	8.3	210	30	14	Rear
SCO10S253F	3.0	76	1.0	25	25000	2.0	0.9	8.3	210	30	14	Front
SCO10S253R	3.0	76	1.0	25	25000	2.0	0.9	8.3	210	30	14	Rear

**General:** Air Inlet Size: 1/4" NPT • Recommended Hose Size: 3/8" (10 mm) • Performance rated @ 90 psig (6.2 bar) air pressure

**Standard Equipment:** Parts List • Safety and Instruction Manual • 1 Blade • Spindle Wrenches & Guard

**Accessories:** Panel and Cutoff Saw Accessories, see page 51

ANGLE CUTOFF TOOLS (TYPE 1)

Features:

Heavy duty spiral bevel gearing for durability and smooth operation  
4 position indexable angle head  
360 degree rotatable guard



SCO10A106



Angle Cutoff Tool

Model Number	Blade Diameter		Depth of Cut		Free Speed rpm	Weight		Length		Air Consumption		Spindle Thread	Exhaust
	in	mm	in	mm		lb	kg	in	mm	cfm	l/s		
SCO7A184	4.0	100	1.2	30	18000	2.5	1.4	6.4	163	25	12	3/8"-24	Front
SCO10A106	6.0	150	2.0	51	10000	3.7	1.7	8.75	220	35	16.5	5/8"-11	Rear
SCO10A125	5.0	125	1.5	38	12000	3.5	1.6	8.75	220	35	16.5	5/8"-11	Rear
SCO10A184	4.0	100	1.2	30	18000	2.5	1.4	7.75	195	35	16.5	3/8"-24	Rear
SCO10AXL124	4.0	100	1.0	25	12000	3.6	1.6	11.25	285	35	17	3/8"-24	Rear

**General:** Air Inlet Size: 1/4" NPT • Recommended Hose Size: 3/8" (10 mm) • Performance rated @ 90 psig (6.2 bar) air pressure

**Standard Equipment:** Parts List • Safety and Instruction Manual • 1 Blade • Spindle Wrenches & Guard

**Accessories:** Angle Cutoff Tool Accessories, see page 51



SCO1AX124



Angle Metal Body Extended Cutoff Tool

Model Number	Blade Diameter		Depth of Cut		Free Speed rpm	Weight		Length		Air Consumption		Spindle Thread	Exhaust
	in	mm	in	mm		lb	kg	in	mm	cfm	l/s		
<b>1 hp (0.75 kW) – Lever Throttle – Aluminum Housing</b>													
SCO1AX124	4.0	100	1.0	25	12000	3.9	1.8	10.5	267	35	16.5	3/8" - 24	Front
<b>1 hp (0.75 kW) – Lever Throttle – Aluminum Housing with Grip</b>													
SCO1AX124G	4.0	100	1.0	25	12000	3.6	1.6	10.5	267	35	16.5	3/8" - 24	Front
<b>1 hp (0.75 kW) – Lever Throttle – Steel Housing</b>													
SCOS1AX124	4.0	100	1.0	25	12000	4.5	2.0	10.5	267	35	16.5	3/8" - 24	Front
<b>1 hp (0.75 kW) – Lever Throttle – Steel Housing with Grip</b>													
SCOS1AX124G	4.0	100	1.0	25	12000	4.1	1.9	10.5	267	35	16.5	3/8" - 24	Front

**General:** Air Inlet Size: 1/4" NPT • Recommended Hose Size: 3/8" (10 mm) • Performance rated @ 90 psig (6.2 bar) air pressure

**Standard Equipment:** Parts List • Safety and Instruction Manual • 1 Blade • Spindle Wrenches & Guard

**Accessories:** Angle Cutoff Tool Accessories, see page 51



**SAFETY PRECAUTION:** Read and follow all safety and operating instructions.

**WARNING:** Face & eye protection must be worn while operating power tools, per ANSI B186.1



## Belts and Erasers



Hub Set 68918



Eraser 68815



Course Wire Belt 68814



Fine Wire Belt 68813



Medium Stainless Steel Wire Belt 68917



Fine Stainless Steel Wire Belt 68915

Part Number	Description
68918	11mm Hub Set
68815	Rubber Eraser
68814	Course Wire Belt, 23 mm Wide
68910	Course Wire Belt, 11 mm Wide
68911	Medium Wire Belt, 23 mm Wide
68912	Medium Wire Belt, 11 mm Wide
68813	Fine Wire Belt, 23 mm Wide
68913	Fine Wire Belt, 11 mm Wide
68916	Medium Stainless Steel Wire Belt, 23 mm Wide
68917	Medium Stainless Steel Wire Belt, 11 mm Wide
68914	Fine Stainless Steel Wire Belt, 23 mm Wide
68915	Fine Stainless Steel Wire Belt, 11 mm Wide

## Collets



21126



44440

Style	Capacity	Part Number	For Use On
Sioux	1/8"	44522	2S1940
	3/16"	44523	
	1/4"	44440	
	3 mm	66037	
	6 mm	66038	
100 Series	1/4"	21126B	1985
	3/8"	21125	
	1/2"	21124	

## Wheel Guards



2336

Part Number	Wheel Type	Wheel Diameter		For Use On
		in	mm	
2321	27	7	180	1285, 1285L
2336	27	7	180	1291, 1921L

## Signature Series Collets

### 200 SERIES

Heavy Duty Double Tapered Collet  
Collet Nut    Collet    Collet Body



Part Number	Description
74071	Collet Nut
74072	Collet (1/8")
74073	Collet (3/16")
74074	Collet (1/4")
68030	Collet (3/8")
74075	Collet (3 mm)
74076	Collet (6 mm)
68056	Collet (8 mm)
77057	Collet Body SDG Series
74070	Collet Body (1 HP)
74070KIT	Includes 74070, 74071, 74074

### 300 SERIES

Heavy Duty Double Tapered Collet  
Collet Nut    Collet    Collet Body



Part Number	Description
74128	Collet Nut
74124	Collet (3/32")
74121	Collet (1/8")
74120	Collet (1/4")
74122	Collet (3 mm)
74123	Collet (6 mm)
77505	Collet Body SAS Series
74125	Collet Body SDG Series

## Mounting Accessories

7" and 9" Type 27 Depressed Center Wheel  
For use on 5/8" - 11 threaded spindles



510

Part Number	Description
510	Flange Adapter Kit 1 1/4" X 21/32" X 3/32" Washers
512	Flange Nut 3/8" Hex Wrench



**SAFETY PRECAUTION:** Read and follow all safety and operating instructions.  
**WARNING:** Face & eye protection must be worn while operating power tools, per ANSI B186.1

# FINISHING

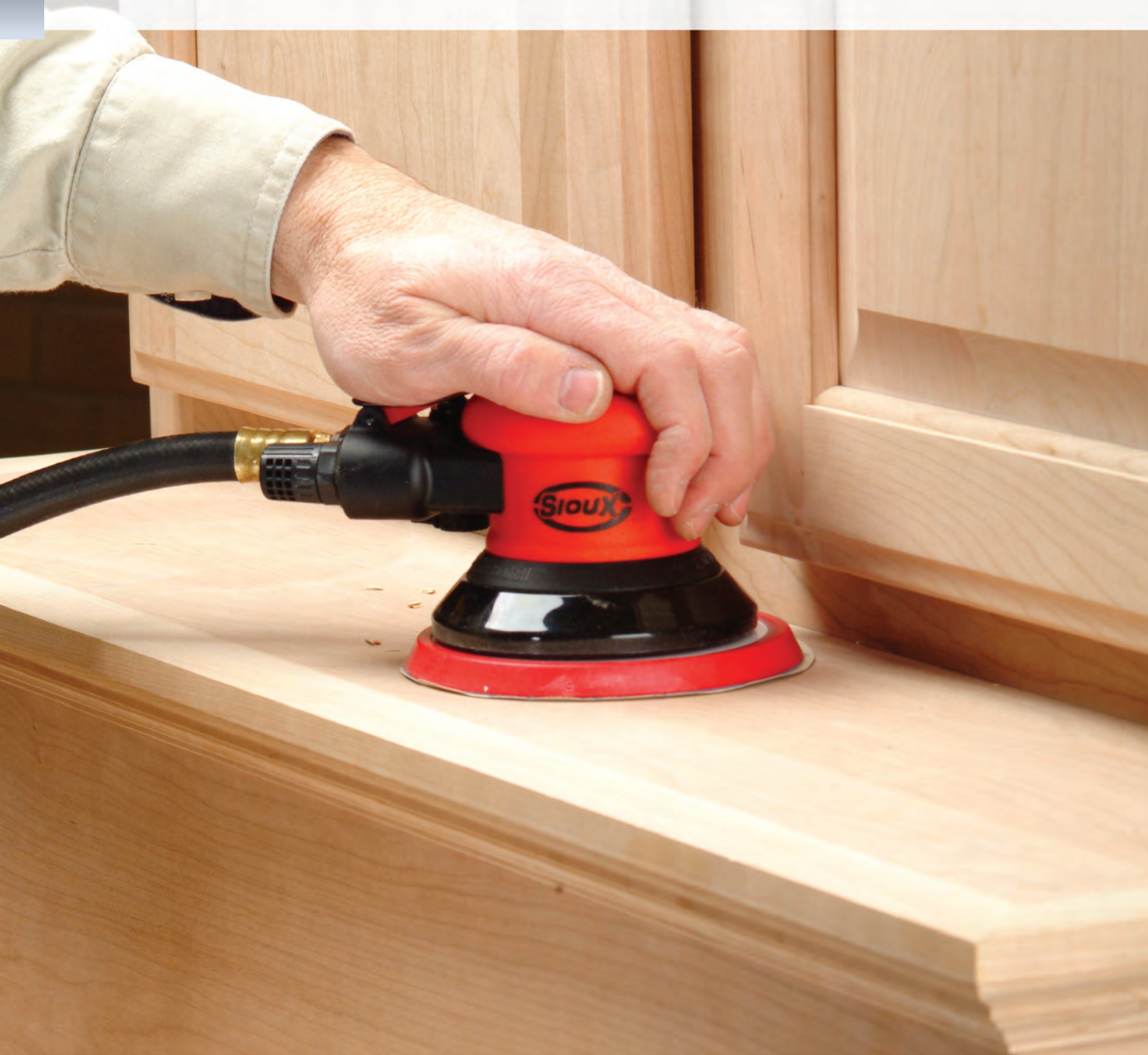

<b>Index</b>	
<b>Sanders</b> . . . . .	<b>54 – 58</b>
<b>Polishers</b> . . . . .	<b>59</b>
<b>Finishing Accessories</b> . . . . .	<b>60-62</b>

# FINISHING

## The Best Way To A Great Finish

Today's manufacturing techniques are constantly changing and improving. This has increased the demands for sanders, polishers and buffers, making them a key segment of the process. Improvements in the industry now result in less waste on castings and molded parts, which shifts the emphasis from material removal to surface finishing. Sioux Tools offers a complete line of state-of-the-art orbital sanders, polishers and buffers that will produce the quality finish you require on your final product.

Sioux sanders are engineered to cover the full range of applications in metal, composite, and wood finishing. Our innovative, lightweight designs ensure they perform to the highest standards while still being comfortable to operate. Each delivers unsurpassed power and performance, resulting in the perfect finish.

### Fit to your application

Different applications require different finishing tools. That's why Sioux Tools offers a variety of sanders and polishers with a wide range of configurations.

The RO2512 Series Random Orbital Sanders come with an orbit diameter of either 3/8" (10 mm), 3/16" (5 mm) or 3/32" (3 mm) and a choice of non-vacuum, self-contained Venturi vacuum or remote vacuum ready.

### Variety to choose from

We also offer pistol grip, right angle, vertical, and straight sanders and polishers. Many of these come with your choice of throttle controls that allow the operator to work the way that's most comfortable.



RO2512-50SNP



SAG03S20



SAS03S122-20

### Finishing Safety

Flying particles can cause eye injury. Proper eye protection must be worn at all times by tools user and bystanders.

A grinding wheel that bursts can cause injury or death. Never mount a grinding wheel or a cutoff wheel on a sander or polisher.

Breathing grinding dust can cause injury. Do not breathe grinding dust. Use approved mask.

Sanders and polishers that do not come to a complete stop before setting aside can cause injury. Be sure the tool has come to a complete stop before setting it aside.

Explosions and fires can cause injury. Only sand metal if the area is free of combustible or explosive materials or vapors.

Contact with sanding disks can cause injury. Wear protective clothing and gloves to protect hands. Keep hands and other body parts away from sanding pads and disks to prevent cutting or pinching.

Sanding or polishing pads, disks or accessories that burst can cause injury. Make sure disks or accessories have a higher speed rating than the tool. Do not exceed rated air pressure.

Prolonged exposure to vibration or an excessive exposed portion of the edge of a disk can cause injury. When using self adhesive sanding disks, make sure to mount them concentrically on the pad.

Tools starting unexpectedly can cause injury. Always remove tool from air supply and activate trigger to bleed air line before making any adjustments, changing accessories, or doing any maintenance or service on tool.

Tools that perform unpredictably can cause injury. Use only sanding and polishing pads, disks and accessories provided or specified by Sioux Tools.



**SIGNATURE SERIES RANDOM ORBITAL SANDERS**



**RO2512-50SNP**



**RO2512-50SRP**



**RO2512-50FVP**

**Performance:**

Power: 0.25 hp (0.19 kW)  
Speed: 12,000 rpm

**Features:**

3/32" (3 mm), 3/16" (5 mm) & 3/8" (10 mm) Orbit Diameters  
Built-in Speed Control  
Ergonomic 24-Position Indexable Grip  
Non-Vacuum, Venturi Vacuum & Remote Vacuum

**RO2512 Series Random Orbital Sanders**



Model Number		Free Speed rpm	Pad Size		Orbit Diameter		Weight		Height		Air Consumption	
PSA Pad	H & L Pad		in	mm	in	mm	lb	kg	in	mm	cfm	l/s
<b>0.25 hp (0.19 kW) – 5/16"-24 Spindle Thread – Non-Vacuum</b>												
RO2512-30FNP	RO2512-30FNH	12000	3.0	75	3/32	3	1.5	0.7	3.3	83	13	6
RO2512-30SNP	RO2512-30SNH	12000	3.0	75	3/16	5	1.5	0.7	3.3	83	13	6
RO2512-35FNP	RO2512-35FNH	12000	3.5	90	3/32	3	1.5	0.7	3.3	83	13	6
RO2512-35SNP	RO2512-35SNH	12000	3.5	90	3/16	5	1.5	0.7	3.3	83	13	6
RO2512-50FNP	RO2512-50FNH	12000	5.0	125	3/32	3	1.5	0.7	3.3	83	13	6
RO2512-50SNP	RO2512-50SNH	12000	5.0	125	3/16	5	1.5	0.7	3.3	83	13	6
RO2512-50CNP	RO2512-50CNH	12000	5.0	125	3/8	10	1.5	0.7	3.3	83	13	6
RO2512-60FNP	RO2512-60FNH	12000	6.0	150	3/32	3	1.5	0.7	3.3	83	13	6
RO2512-60SNP	RO2512-60SNH	12000	6.0	150	3/16	5	1.5	0.7	3.3	83	13	6
RO2512-60CNP	RO2512-60CNH	12000	6.0	150	3/8	10	1.5	0.7	3.3	83	13	6
<b>0.25 hp (0.19 kW) – 5/16"-24 Spindle Thread – Remote Vacuum Ready</b>												
RO2512-30FRP	RO2512-30FRH	12000	3.0	75	3/32	3	1.5	0.7	3.3	83	13	6
RO2512-30SRP	RO2512-30SRH	12000	3.0	75	3/16	5	1.5	0.7	3.3	83	13	6
RO2512-35FRP	RO2512-35FRH	12000	3.5	90	3/32	3	1.5	0.7	3.3	83	13	6
RO2512-35SRP	RO2512-35SRH	12000	3.5	90	3/16	5	1.5	0.7	3.3	83	13	6
RO2512-50FRP	RO2512-50FRH	12000	5.0	125	3/32	3	1.5	0.7	3.3	83	13	6
RO2512-50SRP	RO2512-50SRH	12000	5.0	125	3/16	5	1.5	0.7	3.3	83	13	6
RO2512-50CRP	RO2512-50CRH	12000	5.0	125	3/8	10	1.5	0.7	3.3	83	13	6
RO2512-60FRP	RO2512-60FRH	12000	6.0	150	3/32	3	1.5	0.7	3.3	83	13	6
RO2512-60SRP	RO2512-60SRH	12000	6.0	150	3/16	5	1.5	0.7	3.3	83	13	6
RO2512-60CRP	RO2512-60CRH	12000	6.0	150	3/8	10	1.5	0.7	3.3	83	13	6
<b>0.25 hp (0.19 kW) – 5/16"-24 Spindle Thread – Self-contained Venturi Vacuum</b>												
RO2512-30FVP	RO2512-30FVH	12000	3.0	75	3/32	3	1.5	0.7	3.3	83	13	6
RO2512-30SVP	RO2512-30SVH	12000	3.0	75	3/16	5	1.5	0.7	3.3	83	13	6
RO2512-35FVP	RO2512-35FVH	12000	3.5	90	3/32	3	1.5	0.7	3.3	83	13	6
RO2512-35SVP	RO2512-35SVH	12000	3.5	90	3/16	5	1.5	0.7	3.3	83	13	6
RO2512-50FVP	RO2512-50FVH	12000	5.0	125	3/32	3	1.5	0.7	3.3	83	13	6
RO2512-50SVP	RO2512-50SVH	12000	5.0	125	3/16	5	1.5	0.7	3.3	83	13	6
RO2512-50CVP	RO2512-50CVH	12000	5.0	125	3/8	10	1.5	0.7	3.3	83	13	6
RO2512-60FVP	RO2512-60FVH	12000	6.0	150	3/32	3	1.5	0.7	3.3	83	13	6
RO2512-60SVP	RO2512-60SVH	12000	6.0	150	3/16	5	1.5	0.7	3.3	83	13	6
RO2512-60CVP	RO2512-60CVH	12000	6.0	150	3/8	10	1.5	0.7	3.3	83	13	6

**General:**

Air Inlet Size: 1/4" NPT • Recommended Hose Size: 3/8" (10 mm) • Performance rated @ 90 psig (6.2 bar) air pressure

**Standard Equipment:**

Parts List • Safety and Instruction Manual • Comfort Grip • Backing Pad & Wrench

**Accessories:**

Sander Accessories, see pages 60 – 62



**SAFETY PRECAUTION:** Read and follow all safety and operating instructions.

**WARNING:** Face & eye protection must be worn while operating power tools, per ANSI B186.1



**ORBITAL JITTERBUG SANDER**



**RO2510-44FNC**

**Performance:**

Power: 0.25 hp (0.19 kW)  
Speed: 10,000 rpm

**Features:**

Built-in Speed Control  
Ergonomic 24-Position Indexable Grip

**Orbital Jitterbug Sanders**



Model Number	Paper Size		Orbit Diameter		Weight		Height		Air Consumption Free Speed	
	in	mm	in	mm	lb	kg	in	mm	cfm	l/s
<b>0.25 hp (0.19 kW)</b>										
RO2510-44FNC	3-3/4 x 4-1/4	95 x 105	3/32	3	1.8	0.8	3.5	90	13	6

**General:**

Air Inlet Size: 1/4" NPT • Recommended Hose Size: 3/8" (10 mm) • Performance rated @ 90 psig (6.2 bar) air pressure

**Standard Equipment:**

Parts List • Safety and Instruction Manual

**Accessories:**

Sander Accessories, see pages 60 – 62

**GEARED ORBITAL SANDERS**



**GO459-60SNP**



**GO459-80SRP**

**Performance:**

Power: 0.45 hp (0.34 kW)  
Speed: 900 rpm

**Features:**

3/16" (5 mm) Orbit Diameter  
Built-in Speed Control  
Lever Throttle  
Vacuum & Remote Vacuum  
Ergonomic 24-Position Indexable Grip

**Geared Orbital Sanders**



Model Number		Free Speed	Pad Size		Weight		Height		Air Consumption	
PSA Pad	H & L Pad	rpm	in	mm	lb	kg	in	mm	cfm	l/s
<b>0.45 hp (0.34 kW) Non-Vacuum</b>										
GO459-60SNP	GO459-60SNH	900	6.0	150	4.4	2.0	5.0	127	15	7
GO459-80SNP	GO459-80SNH	900	8.0	200	4.4	2.0	5.0	127	15	7
<b>0.45 hp (0.34 kW) Remote Vacuum</b>										
GO459-60SRP	GO459-60SRH	900	6.0	150	4.4	2.0	5.0	127	15	7
GO459-80SRP	GO459-80SRH	900	8.0	200	4.4	2.0	5.0	127	15	7

**General:**

Air Inlet Size: 1/4" NPT • Recommended Hose Size: 3/8" (10 mm) • Performance rated @ 90 psig (6.2 bar) air pressure

**Standard Equipment:**

Parts List • Safety and Instruction Manual

**Accessories:**

Sander Accessories, see pages 60 – 62



**SAFETY PRECAUTION:** Read and follow all safety and operating instructions.  
**WARNING:** Face & eye protection must be worn while operating power tools, per ANSI B186.1

600 SERIES RANDOM ORBITAL SANDERS

**Performance:**

Power: 0.40 hp (0.30 kW)  
Speed: 10,000 rpm

**Features:**

3/16" (5 mm) Orbit Diameter  
Built-in Speed Control  
Aluminum Housing  
Palm & Lever Throttle



658

600 Series Random Orbital Sanders

Model Number		Free Speed	Pad Size		Orbit Diameter		Weight		Height		Air Consumption	
PSA Pad	H & L Pad	rpm	in	mm	in	mm	lb	kg	in	mm	cfm	l/s
<b>0.40 hp (0.30 kW) – Palm Throttle</b>												
PS690 <sup>1</sup>		10000	5.0	125	3/16	5	2.9	1.3	4.2	107	20	9
697 <sup>1</sup>		10000	6.0	150	3/16	5	2.9	1.3	4.2	107	20	9
<b>0.40 hp (0.30 kW) – Dual Action – Lever Throttle</b>												
658 <sup>1</sup>		10000	5.0	125	3/16	5	3.2	1.5	4.2	107	20	9

For remote vacuum ready add suffix V  
<sup>1</sup>Not CE Certified

**General:**

Air Inlet Size: 1/4" NPT • Recommended Hose Size: 3/8" (10 mm) • Performance rated @ 90 psig (6.2 bar) air pressure

**Standard Equipment:**

Parts List • Safety and Instruction Manual • Backing Pad & Wrench

**Accessories:**

Sander Accessories, see pages 60 – 62

PISTOL GRIP SANDERS



SPS10P18



SDG10P18

**Performance:**

Power: 1 hp (0.75 kW)  
Speed: 6,000 rpm – 21,000 rpm

**Features:**

Trigger Start  
Down-Handle Exhaust  
Comfort Grip

Pistol Grip Sanders



Model Number	Free Speed	Weight		Height		Air Consumption	
	rpm	lb	kg	in	mm	cfm	l/s
<b>1 hp (0.75 kW) – 5" (125 mm) Diameter Backing Pad</b>							
SPS10P6	6000	1.7	0.8	4.5	115	35	17
SPS10P18	18000	1.7	0.8	4.5	115	35	17
<b>1 hp (0.75 kW) – 1/4" Collet</b>							
SDG10P18	18000	1.7	0.8	5.8	145	35	17
SDG10P21	21000	1.7	0.8	5.8	145	35	17

**General:**

Air Inlet Size: 1/4" NPT • Recommended Hose Size: 3/8" (10 mm) • Performance rated @ 90 psig (6.2 bar) air pressure

**Standard Equipment:**

Parts List • Safety and Instruction Manual • Comfort Grip • Backing Pad (SPS only)

**Accessories:**

Sander Accessories, see pages 60 – 62



**SAFETY PRECAUTION:** Read and follow all safety and operating instructions.  
**WARNING:** Face & eye protection must be worn while operating power tools, per ANSI B186.1

RIGHT ANGLE SANDERS



**Performance:**

Power: 0.3 hp (0.22 kW) –  
1 hp (0.75 kW)  
Speed: 12,000 rpm – 23,000 rpm

**Features:**

Lockoff Lever Throttle  
Rear Exhaust  
Comfort Grip



**Right Angle Disc Sanders – 1/4"-20 Internal Thread**

Model Number	Free Speed	Weight		Length		Air Consumption Free Speed		Spindle Thread
	rpm	lb	kg	in	mm	cfm	l/s	
<b>0.3 hp (0.22 kW) – Lever Throttle</b>								
SAS03S122-20	12000	1.1	0.5	5.625	143	11	5.2	1/4"-20
SAS03S202-20	20000	1.1	0.5	5.625	143	11	5.2	1/4"-20
<b>0.5 hp (0.37 kW) – Lever Throttle</b>								
SAS05S122-20	12000	1.6	0.73	6.9	175	23	11	1/4"-20
SAS05S152-20	15000	1.6	0.73	6.9	175	23	11	1/4"-20
SAS05S182-20	18000	1.6	0.73	6.9	175	23	11	1/4"-20
SAS05S232-20	23000	1.3	0.59	5.625	143	23	11	1/4"-20
<b>1 hp (0.75 kW) – Lever Throttle</b>								
SAS10A122-20	12000	2.15	0.98	7.5	190	30	14	1/4"-20
SAS10A152-20	15000	2.15	0.98	7.5	190	30	14	1/4"-20
SAS10A182-20	18000	2.15	0.98	7.5	190	30	14	1/4"-20

**General:**

Air Inlet Size: 1/4" NPT • Recommended Hose Size: 3/8" (10 mm) • Performance rated @ 90 psig (6.2 bar) air pressure

**Standard Equipment:**

Parts List • Safety and Instruction Manual • Support Handle (1 hp Models) • Spindle Wrenches • 300 Series Collet • 1/4"-20 Threaded Arbor

**Accessories:**

Sander Accessories, see pages 60 – 62



300 Series Collet



77016 Threaded Arbor

**Sioux Swivel**

Part Number	Description
1338-25	1/4" non-regulated air swivel connector with safety pin
1338-38	3/8" non-regulated air swivel connector with safety pin
1338-50	1/2" non-regulated air swivel connector with safety pin
1338FC-25	1/4" regulated air swivel connector with safety pin

Allows the air hose to rotate 360° on 2 axes.



1338-25



1338FC-25



**SAFETY PRECAUTION:** Read and follow all safety and operating instructions.  
**WARNING:** Face & eye protection must be worn while operating power tools, per ANSI B186.1

**RIGHT ANGLE SANDERS**



SAS10A324



SAS10AX125



SAS10SX125



SAS10S125



1287L

**Performance:**

Power: 1 hp (0.75 kW)  
Speed: 3,200 rpm – 12,000 rpm

**Features:**

Governed & Non-Governed  
Lockoff Lever Throttle  
Rear Exhaust on SAS Series

**Right Angle Sanders – External Thread Spindle**



Model Number	Free Speed		Pad Diameter		Weight		Length		Air Consumption Under Load		Air Consumption Free Speed		Spindle Thread
	rpm		in	mm	lb	kg	in	mm	cfm	l/s	cfm	l/s	
<b>1 hp (0.75 kW) – Medium Duty Head</b>													
SAS10A324	3200		5.0	125	2.8	1.3	9.25	235	N/A	N/A	35	17	3/8"-24
SAS10A607	6000		7.0	178	2.9	1.3	9.2	234	N/A	N/A	35	17	5/8"-11
SAS10A125	12000		5.0	125	2.2	1.0	7.75	134	N/A	N/A	35	17	5/8"-11
SAS10AX125	12000		5.0	125	3.2	1.45	11.25	285	N/A	N/A	35	17	5/8"-11
<b>1 hp (0.75 kW) – Heavy Duty Head</b>													
SAS10S905	9000		5.0	127	3.5	1.6	8.3	211	N/A	N/A	35	17	5/8"-11
SAS10S125	12000		5.0	125	2.6	1.2	8.3	210	N/A	N/A	35	17	5/8"-11
SAS10SX125	12000		5.0	125	3.6	1.6	11.7	300	N/A	N/A	35	17	5/8"-11
<b>1 hp (0.75 kW) – Governed Speed Control</b>													
1287L <sup>1</sup>	6000		7.0	175	5.9	2.7	11.3	287	35	17	18	8	5/8"-11

<sup>1</sup>Not CE certified.

**General:** Air Inlet Size: 1/4" NPT • Recommended Hose Size: 3/8" (10 mm) • Performance rated @ 90 psig (6.2 bar) air pressure

**Standard Equipment:** Parts List • Safety and Instruction Manual • Support Handle • Spindle Wrenches • Backing Pad & Nut

**Accessories:** Sander Accessories, see pages 60 – 62

**VERTICAL SANDERS**



1290



1290L



VS20AL-727

**Performance:**

Power: 1 hp (0.75 kW) – 2 hp (1.5 kW)  
Speed: 6,000 rpm – 7,200 rpm

**Features:**

Governed & Non-Governed  
Lever & Thumb Throttle  
Side Exhaust  
Overspeed Shutoff Protection (V Series)

**Vertical Sanders**



Model Number	Free Speed		Pad Diameter		Weight		Length		Air Consumption Under Load		Air Consumption Free Speed		Spindle Thread
	rpm		in	mm	lb	kg	in	mm	cfm	l/s	cfm	l/s	
<b>1 hp (0.75 kW) – Thumb Throttle</b>													
1290	5000		7.0	175	4.1	1.9	7.2	183	30	14	38	18	5/8"-11
<b>1 hp (0.75 kW) – Lever Throttle</b>													
1290L	6000		7.0	175	4.1	1.9	7.2	183	30	14	38	18	5/8"-11
<b>2 hp (1.5 kW) Class Vertical Sanders – Governed Speed Control – Lockoff Lever Throttle</b>													
VS20AL-609	6000		9.0	230	7.4	3.3	5.5	145	75	35	26	12	5/8"-11
VS20AL-727	7200		7.0	175	7.4	3.3	5.5	145	75	35	26	12	5/8"-11

**General:** Air Inlet Size: 1/4" NPT • Recommended Hose Size: 3/8" (10 mm) • Performance rated @ 90 psig (6.2 bar) air pressure

**Standard Equipment:** Parts List • Safety and Instruction Manual • Spindle Wrenches • Backing Pad & Nut

**Accessories:** Sander Accessories, see pages 60 – 62



**SAFETY PRECAUTION:** Read and follow all safety and operating instructions.  
**WARNING:** Face & eye protection must be worn while operating power tools, per ANSI B186.1



**RIGHT ANGLE POLISHERS**



SAP10A327



1238L



**Performance:**

Power: 1 hp (0.75 kW)  
Speed: 2,200 rpm – 4,500 rpm

**Features:**

Governed & Non-Governed  
Lockoff Lever Throttle  
Spindle Lock  
Rear Exhaust (SAP)  
Side Exhaust (1238L)

**Right Angle Polishers**

Model Number	Free Speed		Pad Diameter		Weight		Length		Air Consumption Under Load		Air Consumption Free Speed		Spindle Thread
	rpm		in	mm	lb	kg	in	mm	cfm	l/s	cfm	l/s	
<b>1 hp (0.75 kW) - Non-Governed</b>													
SAP10S227	2200		sold seperately		3.3	1.5	9.8	249	N/A	N/A	35	17	5/8"-11
SAP10A327	3200		sold seperately		2.9	1.3	9.2	234	N/A	N/A	35	17	5/8"-11
SAP10A457	4500		sold seperately		2.9	1.3	9.2	234	N/A	N/A	35	17	5/8"-11
<b>1 hp (0.75 kW) – Governed Speed Control</b>													
1238L	3000		8.0	200	7.9 <sup>1</sup>	3.6	11.3	287	33	16	16	8	5/8"-11

<sup>1</sup> Weight includes pad & holder.

**General:**

Air Inlet Size: 1/4" NPT • Recommended Hose Size: 3/8" (10 mm) • Performance rated @ 90 psig (6.2 bar) air pressure

**Standard Equipment:**

(SAP) Parts List • Safety and Instruction Manual • Support Handle • Spindle Wrench  
(1238L) Parts List • Safety and Instruction Manual • Support Handle • Backing Pad & Nut • Wool Polishing Pad • Spindle Wrench

**Accessories:**

Polisher Accessories, see pages 60 – 62

**VERTICAL POLISHERS**



1292L



1292



**Performance:**

Power: 1 hp (0.75 kW)  
Speed: 2,000 rpm – 3,000 rpm

**Features:**

Lever & Thumb Throttle  
Side Exhaust  
Comfort Grips

**Vertical Polishers**

Model Number	Free Speed		Pad Diameter		Weight <sup>1</sup>		Length		Air Consumption Under Load		Air Consumption Free Speed		Spindle Thread
	rpm		in	mm	lb	kg	in	mm	cfm	l/s	cfm	l/s	
<b>1 hp (0.75 kW) – Thumb Throttle</b>													
1296	2000		8.0	200	4.1	1.9	7.1	180	30	14	38	18	5/8"-11
1292	3000		8.0	200	4.1	1.9	7.1	180	30	14	38	18	5/8"-11
<b>1 hp (0.75 kW) – Lever Throttle</b>													
1292L	3000		8.0	200	4.1	1.9	7.1	180	30	14	38	18	5/8"-11

<sup>1</sup> Weight includes pad & holder.

**General:**

Air Inlet Size: 1/4" NPT • Recommended Hose Size: 3/8" (10 mm) • Performance rated @ 90 psig (6.2 bar) air pressure

**Standard Equipment:**

Parts List • Safety and Instruction Manual • Spindle Wrenches • Backing Pad & Nut • Polishing Pad

**Accessories:**

Polisher Accessories, see pages 60 – 62



**SAFETY PRECAUTION:** Read and follow all safety and operating instructions.  
**WARNING:** Face & eye protection must be worn while operating power tools, per ANSI B186.1

### Comfort Grips



66667

Part Number	Description	For Use On
66667	Cushion Grip	690 series

### Speed-Lok Backing Pads

For use on SAS series sanders



587M



588M

Part Number	Diameter		Hex Size
	in	mm	
587M	2	50	1/4"
588M	3	75	1/4"

### Fibre Backing Discs

**Part No 586**

For use on SPS10P series sanders

Packaged in cartons of 6

Qty 3 – 3" (75 mm)

Qty 3 – 4-1/2" (110 mm)



### Backing Pads

For use on SPS10P series sanders



2344

Part Number	Thread	Diameter	
		in	mm
2344	(3/8-24) & (5/8-11)	5	125

Includes disc nut 563

### 7" (175 mm) Sanding Kits

For use on 1287, 1287L, 1290, 1290L & VS20 Series



545H

Part Number	Description
<b>545 Standard Kit</b>	
544	Disc holder
548	Backing disc with lock nut
68015	Wrench
<b>545H Heavy-Duty Kit</b>	
544	Disc holder
548H	Heavy-duty backing disc with lock nut
68015	Wrench



**SAFETY PRECAUTION:** Read and follow all safety and operating instructions.  
**WARNING:** Face & eye protection must be worn while operating power tools, per ANSI B186.1

### Orbital Sander Backing Pads

Sioux random orbital backing pads are medium density, urethane pads rated for speeds up to 13,000 rpm. The 5" pads are a 3/8" thick with low profile design, while the 6" pads are 5/8" thick with tapered profile for fine feathering in corners or around edges.

5/16" - 24 Spindle Thread



591



592



593



593V



593SV



594



594V

Part Number	Diameter		Backing	Profile	Style
	in	mm			
591	3	75	PSA	Low	Vac/Non-Vac
591J	3	75	H & L	Low	Vac/Non-Vac
592	3.5	90	PSA	Tapered	Vac/Non-Vac
592J	3.5	90	H & L	Tapered	Vac/Non-Vac
593	5	125	PSA	Low	Non-Vac
593V	5	125	PSA	Low	Vacuum
593J	5	125	H & L	Low	Non-Vac
593JV	5	125	H & L	Low	Vacuum
593SV	5	125	PSA	Low	Screen Vac
594	6	150	PSA	Tapered	Non-Vac
594V	6	150	PSA	Tapered	Vacuum
594J	6	150	H & L	Tapered	Non-Vac
594JV	6	150	H & L	Tapered	Vacuum
594SV	6	150	PSA	Low	Screen Vac

PSA – Vinyl face for pressure sensitive adhesive sanding discs  
 H & L – Hook and loop face

### Polishing Accessories



1211B



1220



847

Part Number	Description
846C*	Backing pad (Includes 524)
524*	Retaining nut
1211B*	Wool polishing pad
847	Hook & loop backing pad
1220	Hook & loop polishing pad
843	Tie-on wool bonnet (pkg 10)

\* Standard equipment on polishers

### Vacuum Conversion Kits



665

Part Number	For Use On
665	658, 690, 758, 790



**SAFETY PRECAUTION:** Read and follow all safety and operating instructions.  
**WARNING:** Face & eye protection must be worn while operating power tools, per ANSI B186.1

**Dustless Vacuum Shrouds**

**Random Orbital Sander Vacuum Shroud Sioux Models RO25VS-5 and RO25VS-6**



- Fit RO25 Series Random Orbital Sanders
- Available For 5" Or 6" Sanders
- Captures 99% Of Airborne Dust
- Protects Workers From Harmful Airborne Dust
- Flexible And Transparent For Better Visibility
- Includes 6 Ft. Vacuum Hose

Part Number	Description
RO25VS-5	5" Vacuum Shroud
RO25VS-6	6" Vacuum Shroud

**Drill and Rivet Shaver Vacuum Shroud Sioux Model DRVS150**



- Can Be Used With Any Drill Or Rivet Shaver
- Suction Holds The Shroud In Place
- Great For Tight Spaces
- Can Be Used For Drilling Holes Up To 1 3/8" Diameter
- Captures 99% Of Airborne Dust
- Protects Workers From Harmful Airborne Dust
- Transparent For Better Visibility
- Includes 6 Ft. Vacuum Hose





# PERCUSSIVE



PREPARED BY: **WARNING** METAL WORKERS  
PREVENT WHEEL SEPARATION  
RECOMMENDED TIGHTENING TORQUE FOR DUST WHEEL MOUNTING NUTS IS 45-50 LB-FT. APPLY TO BALL BEAT AND HUB-PILOT MOUNTING SYSTEMS WITH 3/4-16 OR 1/2-13 STUDS FOR ALUMINUM AND STEEL WHEELS. CHECK NUTS FREQUENTLY 50-100 MILES AFTER INITIAL IN-SERVICE DATE AND AT INTERVALS NOT TO EXCEED 2500 MILES AND TIGHTEN TO MAINTAIN RECOMMENDED TORQUE.  
FAILURE TO HEED THIS WARNING CAN RESULT IN PROPERTY DAMAGE. SERIOUS INJURY OR DEATH.

Index	
Scalers	65 – 66
Hammers	66
Percussive Accessories	67 – 69

# PERCUSSIVE

Hammering Home A Point

Percussive tools, such as hammers, chippers and scalers are commonly used in very abusive environments found in industries such as foundry and construction. Sioux Tools offers a variety of sizes, capacities and accessories built durable to ensure long life under tough operating conditions. We build them to work hard on the job, but not on you!

## Industrial Tools

Sioux offers powerful hammers that deliver up to 2,500 blows per minute (bpm), with steel rivet capacities of 5/32" (4 mm) to 1/4" (6.4 mm) and stroke lengths from 2" (50 mm) to 4" (100 mm).

## Percussive Safety

Never operate a hammer without proper retainer in place. Always disconnect air line before changing chisels. Face and eye protection must be worn while operating tools. All chisels, rivet sets and other accessories should be checked for cracks, excessive wear, or other physical damage before each use. Accessories that show damage should be replaced immediately.



**SQUARE SHANK SCALERS**



**Performance:**

Stroke: 1.1" (28 mm)  
 Bore: 1" (25 mm)  
 Blows per Minute: 4,600

**Features:**

Lever and Push/Pull Start  
 Quick Release Retainer  
 Adjustable Needle Length

SC4 series scalers accept notched, square shank chisels and accessories. Each can be quickly converted between chisel and needle styles.



**Square Shank**



**Square Shank Scalers**

Model Number	Stroke Length		Bore Diameter		Blows per Minute	Weight		Length		Side To Center		Air Consumption	
	in	mm	in	mm		lb	kg	in	mm	in	mm	cfm	l/s
<b>Chisel Scaler – Lever Throttle</b>													
SC41011AL-C	1.1	28	1.0	25	4600	4.6	2.1	10.5	263	0.9	23	12	6
<b>Chisel Scaler – Push/Pull Throttle</b>													
SC41011AU-C	1.1	28	1.0	25	4600	4.6	2.1	12.0	300	0.9	23	12	6
<b>Needle Scaler – Lever Throttle</b>													
SC41011AL-N5	1.1	28	1.0	25	4600	6.3	2.9	15.3	383	1.0	25	12	6
<b>Needle Scaler – Push/Pull Throttle</b>													
SC41011AU-N5	1.1	28	1.0	25	4600	6.3	2.9	16.8	420	1.0	25	12	6

**General:**

Air Inlet Size: 1/4" NPT • Recommended Hose Size: 3/8" (10 mm) • Performance rated @ 90 psig (6.2 bar) air pressure

**Standard Equipment:**

Parts List • Safety and Instruction Manual • 7" flat chisel (chisel scalers) • 5" scaler needles (needle scalers)

**Accessories:**

Scaler Accessories, see pages 67 – 69



**OCTAGON SHANK SCALERS**

**Performance:**

Stroke: 1" (25 mm)  
 Bore: 15/16" (23 mm)  
 Blows per Minute: 4,300

**Features:**

Lever Throttle  
 Quick Release Retainer  
 Adjustable Needle Length

SC8 series scalers accept notched, octagon shank chisels and accessories. Each can be quickly converted between chisel and needle styles.



**Octagon Shank**



**Octagon Shank Scalers**

Model Number	Stroke Length		Bore Diameter		Blows per Minute	Weight		Length		Side To Center		Air Consumption	
	in	mm	in	mm		lb	kg	in	mm	in	mm	cfm	l/s
<b>Chisel Scaler – Octagon Shank – Lever Throttle</b>													
SC80910AL-C	1.0	25	15/16	23	4300	4.0	1.7	15	375	0.8	20	12	6
<b>Needle Scaler – Octagon Shank – Lever Throttle</b>													
SC80910AL-N5	1.0	25	15/16	23	4300	6.2	2.7	17	425	0.9	23	12	6

**General:**

Air Inlet Size: 1/4" NPT • Recommended Hose Size: 3/8" (10 mm) • Performance rated @ 90 psig (6.2 bar) air pressure

**Standard Equipment:**

Parts List • Safety and Instruction Manual • 7" flat chisel (chisel scalers) • 5" scaler needles (needle scalers)

**Accessories:**

Scaler Accessories, see pages 67 – 69

**SC4 Scaler Kit**

**Part No. SC41011AL-K**

- SC4 Lever Needle Scaler
- Additional Set of Needles
- 3/4" x 7" Flat Chisel
- 1-3/8" x 7" Flat Chisel
- 1-3/8" x 7" Spoon Chisel
- Custom Carrying Case



**SC8 Scaler Kit**

**Part No. SC80910AL-K**

- SC8 Needle Scaler
- Additional Set of Needles
- 3/4" x 7" Flat Chisel
- 1-3/8" x 7" Flat Chisel
- 1-3/8" x 7" Spoon Chisel
- Custom Carrying Case



**SAFETY PRECAUTION:** Read and follow all safety and operating instructions.  
**WARNING:** Face & eye protection must be worn while operating power tools, per ANSI B186.1



## PISTON SCALERS

### Performance:

Stroke: 13/16" (21 mm)  
 Bore: 1" (25 mm)  
 Blows per Minute: 5,200

### Features:

Removable Side Handle (SC3 series)  
 Lever Operated Handle  
 Rugged Steel Body

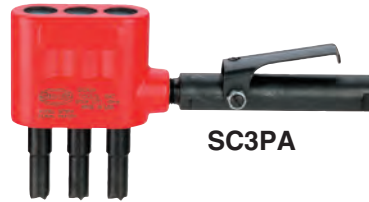

SC3PA



### Piston Scalers

Model Number	Stroke Length		Bore Diameter		Blows per Minute	Weight		Length		Side to Center		Air Consumption Free Speed		Piston Type
	in	mm	in	mm		lb	kg	in	mm	in	mm	cfm	l/s	
<b>Triple Piston Scaler</b>														
SC3PA	13/16	21	1.0	25	5200	8.3	3.8	11	280	7/8	22	15	7	Steel
SC3PA-C	13/16	21	1.0	25	5200	8.3	3.8	11	280	7/8	22	15	7	Carbide Tipped

**General:** Air Inlet Size: 1/4" NPT • Recommended Hose Size: 3/8" (10 mm) • Performance rated @ 90 psig (6.2 bar) air pressure

**Standard Equipment:** Parts List • Safety and Instruction Manual

**Accessories:** Scaler Accessories, see pages 67 – 69

### Replacement Pistons

Part Number	Description
2387	Standard Steel Piston
2388	Standard Steel Piston (2" Longer Than Standard)
2390	Carbide Tipped Piston (Star Point)
2391	Solid Carbide Piston (Chisel Point)

## HAMMERS

### Performance:

Rivet Capacity: 5/32" (4.0 mm) – 1/4" (6.4 mm)  
 Stroke: 2" (50 mm) – 4" (100 mm)  
 Bore: 0.6" (15 mm)

### Features:

Pistol Grip  
 Teasing Throttle Trigger Start  
 Accepts .401 Parker Taper Rivet Sets and Chisels



270A

270A-4

### Hammers

Model Number	Steel Rivet Capacity		Stroke Length		Bore Diameter		Blows per Minute	Weight		Length		Side To Center		Air Consumption	
	in	mm	in	mm	in	mm		lb	kg	in	mm	in	mm	cfm	l/s
270A-2	5/32	4.0	2.0	50	0.6	15	2500	3.0	1.4	5.8	147	1.1	28	8	4
270A	3/16	4.8	3.0	75	0.6	15	2000	3.2	1.5	6.8	173	1.1	28	8	4
270A-4	1/4	6.4	4.0	100	0.6	15	1700	3.5	1.6	7.8	198	1.1	28	8	4

**General:** Air Inlet Size: 1/4" NPT • Recommended Hose Size: 3/8" (10 mm) • Performance rated @ 90 psig (6.2 bar) air pressure

**Standard Equipment:** Parts List • Safety and Instruction Manual • Beehive Retainer

**Accessories:** Hammer Accessories, see pages 67 – 69

## FOUR BOLT CHIPPING HAMMERS

### Performance:

Stroke: 2" (50 mm) – 4" (100 mm)  
 Bore: 1-1/8" (29 mm)

### Features:

Round Front End Bushing or Hex Front End Bushing



CH43A-R



### Four Bolt Chipping Hammers

Model Number	Bore		Stroke		Blows per Minute	Weight		Length		Side To Center		Air Consumption	
	in	mm	in	mm		lb	kg	in	mm	in	mm	cfm	l/s
<b>Four Bolt Chipping Hammer – Round Front End Bushing</b>													
CH42A-R	1-1/8	29	2.0	50	2100	18.0	8.0	16	405	1-5/8	41	33	15.6
CH43A-R	1-1/8	29	3.0	75	1650	19.0	8.6	17	430	1-5/8	41	34	16.0
CH44A-R	1-1/8	29	4.0	100	1375	20.0	9.0	18	455	1-5/8	41	35	16.5
<b>Four Bolt Chipping Hammer – Hex Front End Bushing</b>													
CH42A-H	1-1/8	29	2.0	50	2100	18.0	8.0	16	405	1-5/8	41	33	15.6
CH43A-H	1-1/8	29	3.0	75	1650	19.0	8.6	17	430	1-5/8	41	34	16.0
CH44A-H	1-1/8	29	4.0	100	1375	20.0	9.0	18	455	1-5/8	41	35	16.5

**General:** Air Inlet Size: 7/8"-24 NPT • Recommended Hose Size: 3/8" (10 mm) • Performance rated @ 90 psig (6.2 bar) air pressure

**Standard Equipment:** Parts List • Safety and Instruction Manual

**Accessories:** Four Bolt Chipper Accessories, see pages 67 – 69



**SAFETY PRECAUTION:** Read and follow all safety and operating instructions.

**WARNING:** Face & eye protection must be worn while operating power tools, per ANSI B186.1



Four Bolt Chipper Accessories

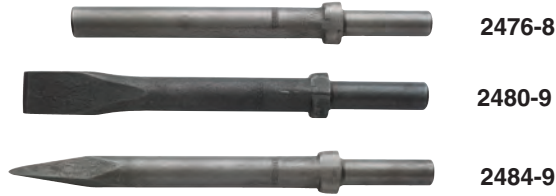

Part Number	For Use On
2476-8	Blank, 8", Oval Collar, Rd Shank
2477-8	Blank, 8", Oval Collar, Hex Shank
2478-8	Blank, 8", Rd Collar, Rd Shank
2479-8	Blank, 8", Rd Collar, Hex Shank
2476-11B	Blank, 11", Oval Collar, Rd Shank
2477-11	Blank, 11", Oval Collar, Hex Shank
2478-11	Blank, 11", RD Collar, Rd Shank
2479-11	Blank, 11", Rd Collar, Hex Shank
2480-9	Chisel, 9", Oval Collar, Rd Shank
2481-9	Chisel, 9", Oval Collar, Hex Shank
2482-9	Chisel, 9", Rd Collar, Rd Shank
2483-9	Chisel, 9", Rd Collar, Hex Shank
2480-12	Chisel, 12", Oval Collar, Rd Shank
2481-12	Chisel, 12", Oval Collar, Hex Shank
2482-12	Chisel, 12", Rd Collar, Rd Shank
2483-12	Chisel, 12", Rd Collar, Hex Shank
2480-18	Chisel, 18", Oval Collar, Rd Shank
2481-18	Chisel, 18", Oval Collar, Hex Shank
2482-18	Chisel, 18", Rd Collar, Rd Shank
2483-18	Chisel, 18", Rd Collar, Hex Shank
2480-24	Chisel, 24", Oval Collar, Rd Shank
2481-24	Chisel, 24", Oval Collar, Hex Shank
2484-9	Moil Point, 9", Oval Collar, Rd Shank
2485-9B	Moil Point, 9", Oval Collar, Hex Shank
2486-9	Moil Point, 9", Rd Collar, Rd Shank
2487-9	Moil Point, 9", Rd Collar, Hex Shank
2484-12	Moil Point, 12", Oval Collar, Rd Shank
2485-12	Moil Point, 12", Oval Collar, Hex Shank
2486-12	Moil Point, 12", Rd Collar, Rd Shank
2487-12	Moil Point, 12", Rd Collar, Hex Shank
2484-18	Moil Point, 18", Oval Collar, Rd Shank
2485-18	Moil Point, 18", Oval Collar, Hex Shank
2486-18	Moil Point, 18", Rd Collar, Rd Shank
2487-18	Moil Point, 18", Rd Collar, Hex Shank
2484-24B	Moil Point, 24", Oval Collar, Rd Shank
2485-24	Moil Point, 24", Oval Collar, Hex Shank
2486-24	Moil Point, 24", Rd Collar, Rd Shank

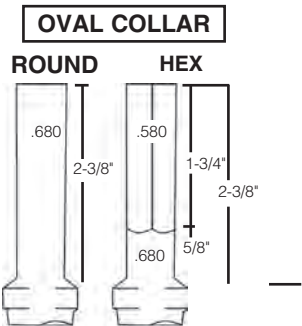

Four Bolt Chipper Accessories



Part Number	For Use On
2488-9	Chisel, 1-1/2" X 9", Oval Collar, Rd Shank
2489-9	Chisel, 1-1/2" X 9", Oval Collar, Hex Shank
2490-9	Chisel, 1-1/2" X 9", Rd Collar, Rd Shank
2491-9	Chisel, 1-1/2" X 9", Rd Collar, Hex Shank
2488-12	Chisel, 1-1/2" X 12", Oval Collar, Rd Shank
2489-12	Chisel, 1-1/2" X 12", Oval Collar, Hex Shank
2490-12	Chisel, 1-1/2" X 12", Rd Collar, Rd Shank
2491-12	Chisel, 1-1/2" X 12", Rd Collar, Hex Shank
2488-18	Chisel, 1-1/2" X 18", Oval Collar, Rd Shank
2489-18	Chisel, 1-1/2" X 18", Oval Collar, Hex Shank
2490-18	Chisel, 1-1/2" X 18", Rd Collar, Rd Shank
2491-18	Chisel, 1-1/2" X 18", Rd Collar, Hex Shank
2492-9	Chisel, 2" X 9", Oval Collar, Rd Shank
2493-9	Chisel, 2" X 9", Oval Collar, Hex Shank
2494-9	Chisel, 2" X 9", Rd Collar, Rd Shank
2495-9B	Chisel, 2" X 9", Rd Collar, Hex Shank
2492-12	Chisel, 2" X 12", Oval Collar, Rd Shank
2493-12	Chisel, 2" X 12", Oval Collar, Hex Shank
2494-12	Chisel, 2" X 12", Rd Collar, Rd Shank
2495-12	Chisel, 2" X 12", Rd Collar, Hex Shank
2492-18	Chisel, 2" X 18", Oval Collar, Rd Shank
2493-18	Chisel, 2" X 18", Oval Collar, Hex Shank
2494-18	Chisel, 2" X 18", Rd Collar, Rd Shank
2495-18	Chisel, 2" X 18", Rd Collar, Hex Shank
2496-9	Bushing Tool, Oval Collar, Rd Shank
2497-9	Bushing Tool, Oval Collar, Hex Shank
2498-9	Bushing Tool, Rd Collar, Rd Shank
2499-9	Bushing Tool, Rd Collar, Hex Shank
2470	Quick Change Retainer

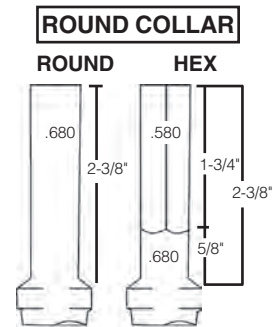

**SAFETY PRECAUTION:** Read and follow all safety and operating instructions.  
**WARNING:** Face & eye protection must be worn while operating power tools, per ANSI B186.1

Scaler Accessories



Square Shank



Octagon Shank



SC4 Chisels	SC8 Chisels	Description	Length		Width	
			in	mm	in	mm
2187	2287	Hardened Blank	7	175	5/8	16
2188	2288	Flat Chisel	7	175	3/4	19
2189	2289	Flat Chisel	7	175	1-3/8	35
2190	2290	Spoon Chisel	7	175	1-3/8	35
2191	2291	Flat Chisel	7	175	2	50
2192	2292	Flat Chisel	12	300	5/8	16
2193	2293	Flat Chisel	12	300	1-3/8	35
2194	2294	Spoon Chisel	12	300	1-3/8	35
2195	2295	Flat Chisel	12	300	2	50
2196	2296	Flat Chisel	18	450	5/8	16
2197	2297	Flat Chisel	18	450	1-3/8	35
2198	2298	Spoon Chisel	18	450	1-3/8	35
2199	2299B	Flat Chisel	18	450	2	50

Scaler Kits



SC4 Scaler Kit

Part No. SC41011AL-K

- SC4 Lever Needle Scaler
- Additional Set of Needles
- 3/4" x 7" Flat Chisel
- 1-3/8" x 7" Flat Chisel
- 1-3/8" x 7" Spoon Chisel
- Custom Carrying Case



SC8 Scaler Kit

Part No. SC80910AL-K

- SC8 Needle Scaler
- Additional Set of Needles
- 3/4" x 7" Flat Chisel
- 1-3/8" x 7" Flat Chisel
- 1-3/8" x 7" Spoon Chisel
- Custom Carrying Case

Hammer Accessories

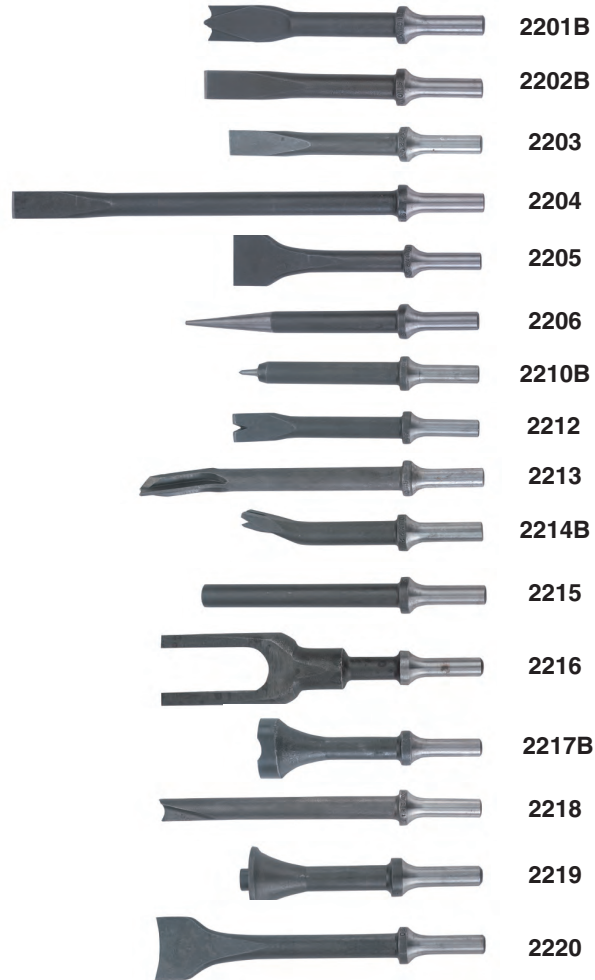

270A Chisels	Description	Width		Length	
		in	mm	in	mm
2201B*	Cutter	5/8	16	6	150
2202B	Chisel	5/8	16	6	150
2203	Rivet Buster	5/8	16	5-1/2	140
2204	Expansion Chisel	5/8	16	11	280
2205*	Scraper	1-1/4	30	6	150
2206	Punch			7	175
2210B	Punch			5	127
2212	Spot Weld Breaker			6	150
2213	Splitter			8	200
2214B	Edging Chisel			5	140
2215	Blank Chisel			6	150
2216*	Fork Chisel			6-7/8	175
2217B*	Rust Breaker			5-1/4	135
2218	Bushing Cutter			7	175
2219*	Bushing Driver			4-1/2	115
2220*	Bushing Chisel	1-5/8	40	7	175

\* Use 2208 Retainer

Scaling Needles



Part Number	Diameter	Length	Quantity	Used On
2260B	0.12"	5"	19	SC4, SC8 Scalers
2262	0.12"	7"	19	SC4, SC8 Scalers



**SAFETY PRECAUTION:** Read and follow all safety and operating instructions.  
**WARNING:** Face & eye protection must be worn while operating power tools, per ANSI B186.1

## Beehive Spring Retainers



Part Number	Description
2207	Chisel Retainer Spring (Use with all except those listed below)
2208	Must use 2208 with 2201B, 2205, 2216, 2217B, and 2219, 2220, 2239, 2244, 2245, 2246, 2247

## 270 Rivet Sets

.401 Parker Taper Shank



Rivet Head Cupping	Rivet Diameter Size				
	3/32" Part No	1/8" Part No	5/32" Part No	3/16" Part No	1/4" Part No
Button Head	N/A	2229	2230B	2231	2244*
Round Head	2232	2233	2234B	2235	2245*
Brazier Head	2236	2237B	2238	2239	2246*
Universal Head	2240	2241B	2242B	2243B*	2247*

3-1/2" (90 mm) overall length  
\* Use 2208 Retainer

## Rivet Set Profiles

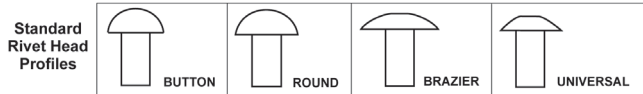

**SAFETY PRECAUTION:** Read and follow all safety and operating instructions.  
**WARNING:** Face & eye protection must be worn while operating power tools, per ANSI B186.1



# SPECIALTY



Index		
Routers	.....	72
Clinch Nut Tools	.....	74
Tappers	.....	75
Rivet Shavers	.....	75
Skin Clamp Runners	.....	76
Saws	.....	76 – 77
Nibblers & Shears	.....	77
Aerospace	.....	79 – 80
Specialty Accessories	.....	81 – 82



# SPECIALTY

## Special Applications Require Special Tools

Sioux Tools has a superb selection of specialty tools designed for very specific applications, and as always, we manufacture the finest tools in the industry.

### Routers

Sioux offers a selection of routers and laminate trimmers in 1.0 hp (0.75 kW) or 1.5 hp (1.1 kW) configurations. They feature lockoff lever, twist or finger throttles and come with a selection of different bases.

### Tappers

Choose from pistol grip or inline configurations. The pistol grip offers chuck capacity from No. 10 thru 1/2" size.

### Nibbler and Shear

Our 1.0 hp (0.75 kw) nibbler and shear has the power for use on cold rolled sheet steel up to 18 gauge.

### Shears

This versatile tool cuts 18 gauge steel and plastics up to 3/32" thick. It also makes straight or curve cuts clean and smooth.

### Aircraft Specialty Tools

Sioux Tools offers several specialized tools for the aircraft industry such as Skin Clamp Runners, which are available in pistol grip or our exclusive Z-handle design. Rivet Shavers come in both pistol grip and inline configurations, with speeds up to 21,000 rpm.

### Clinch Nut Tools

As manufacturing trends continue to evolve manufacturers are finding more and more uses for thin wall assembly applications. Sioux Tools has a selection of Clinch Nut tools that handle these unique fasteners with precision and ease, and our Rapid Reverse feature makes them the best Clinch Nut tool on the market today.

### Air Powered Saws

Sioux Tools offers an outstanding and powerful Reciprocating Saw, offering variable speed control for precise cutting action in any application.



**ROUTERS**

SRT10S25N



SRT10S25B



SRT10S25BB



SRT10S25LT



**Performance:**

Power: 1 hp (0.75 kW)  
 Speed: 18,000 rpm – 25,000 rpm  
 Collet Size: 1/4" (6 mm)

**Features:**

Lockoff Lever Throttle  
 Front Exhaust  
 Interchangeable Base  
 Built-in Speed Control

**1 hp (0.75 kW) Routers**



Model Number	Collet Size	Free Speed	Weight		Height		Maximum Air Consumption	
		rpm	lb	kg	in	mm	cfm	l/s
<b>Template Nose*</b>								
SRT10S18N	1/4	18000	2.1	0.95	9.0	230	30	14
SRT10S18M6N	6 mm	18000	2.1	0.95	9.0	230	30	14
SRT10S25N	1/4	25000	2.1	0.95	9.0	230	30	14
SRT10S25M6N	6 mm	25000	2.1	0.95	9.0	230	30	14
<b>3" Base</b>								
SRT10S18B	1/4	18000	2.1	0.95	9.0	230	30	14
SRT10S18M6B	6 mm	18000	2.1	0.95	9.0	230	30	14
SRT10S18BB	1/4	18000	2.6	1.15	8.3	210	30	14
SRT10S25B	1/4	25000	2.1	0.95	9.0	230	30	14
SRT10S25M6B	6 mm	25000	2.1	0.95	9.0	230	30	14
SRT10S25BB	1/4	25000	2.6	1.15	8.3	210	30	14
<b>Laminate Trimmer</b>								
SRT10S18LT	1/4	18000	2.9	1.30	9.3	235	30	14
SRT10S25LT	1/4	25000	2.9	1.30	9.3	235	30	14

\*Template guides must be ordered separately, page 82

**General:** Air Inlet Size: 1/4" NPT • Recommended Hose Size: 3/8" (10 mm) • Performance rated @ 90 psig (6.2 bar) air pressure

**Standard Equipment:** Parts List • Safety and Instruction Manual • Base/Head Assembly, Collet, Collet Wrenches

**Accessories:** Router Accessories, see pages 81 – 82

**Performance:**

Power: 1.5 hp (1.2 kW)  
 Speed: 20,000 rpm  
 Collet Size: 1/4" – 1/2"

**Features:**

Twist and Finger Throttle  
 4" (102 mm) or 6" (152 mm)  
 Diameter Base  
 Side Exhaust



1981F



1980



RT1983

**1.5 hp (1.2 kW) Routers**

Model Number	Collet Size	Free Speed	Weight		Height		Base Diameter		Maximum Air Consumption	
		rpm	lb	kg	in	mm	in	mm	cfm	l/s
<b>Finger Throttle</b>										
1981F	1/2"	20000	6.0	2.7	9.8	248	4.0	102	38	18
<b>Twist Throttle</b>										
1980A	1/4"	20000	4.5	2.0	7.6	193	4.0	102	38	18
1980	3/8"	20000	4.5	2.0	7.6	193	4.0	102	38	18
RT1981	1/2"	20000	4.5	2.0	7.6	193	4.0	102	38	18
1982A	1/4"	20000	7.5	3.4	8.3	211	6.0	152	38	18
RT1982	3/8"	20000	7.5	3.4	8.3	211	6.0	152	38	18
RT1983	1/2"	20000	7.5	3.4	8.3	211	6.0	152	38	18

**General:** Air Inlet Size: 3/8" NPT • Recommended Hose Size: 3/8" (10 mm) • Performance rated @ 90 psig (6.2 bar) air pressure

**Standard Equipment:** Parts List • Safety and Instruction Manual • Base & Collet Wrenches

**Accessories:** Router Accessories, see pages 81 – 82



**SAFETY PRECAUTION:** Read and follow all safety and operating instructions.

**WARNING:** Face & eye protection must be worn while operating power tools, per ANSI B186.1

# SPECIALTY

## The Fastest Way Out of a Clinch

Sioux Tool's new rapid reverse Clinch Nut Tools are meeting the demand of today's manufacturing marketplace with versatility and simplicity. Clinch nuts, also known as captive nuts, provide a reliable means of securing assembly components in thin wall applications. These unique fasteners are inserted into predrilled holes in thin materials such as sheet metal, and with the aid of a Sioux Clinch Nut Tool, compress and expand to clamp the material. This process creates a strong, secure base with a male or female thread for assembling additional components.

### Installing Clinch Nut Fasteners

When installing clinch nut fasteners, the key to achieving high productivity with accurate, repeatable results is matching the right tool and fastener to your application. The right combination of rundown speed and stall torque in conjunction with a quick reverse method for disengaging the tool, will provide the best results. The Sioux SCN series tools offer higher torque in a wide range of speeds so you can match the right tool to your application. Our powerful tools allow you to use faster rundown speeds while maintaining high torque output, plus our exclusive Rapid Reverse feature makes short work of direction changes ensuring fast disengagement from the fastener.

### Reducing Physical Load

The ergonomic pistol housing with comfort rubber grip ensures operator comfort while maintaining superb balance and control. The powerful, precision motor ensures fast and consistent installation of fasteners in a variety of applications, and the wide selection of speeds and threads in both English and metric sizes make Sioux Tools your choice for all your clinch nut applications.

### Clinch Nut Installation Procedure

**Step 1** – Pre-drill hole for fastener.



**Step 2** – Insert fastener.



**Step 3** – Thread tool into fastener.



**Step 4** – Run tool to collapse fastener.  
Reverse tool to release.

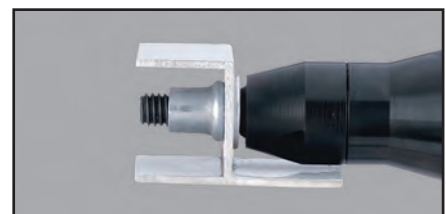

**Step 5** – Assemble.

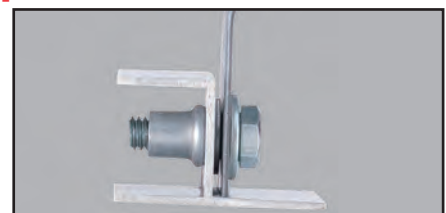

**SAFETY PRECAUTION:** Read and follow all safety and operating instructions.

**WARNING:** Face & eye protection must be worn while operating power tools, per ANSI B186.1

CLINCH NUT TOOLS

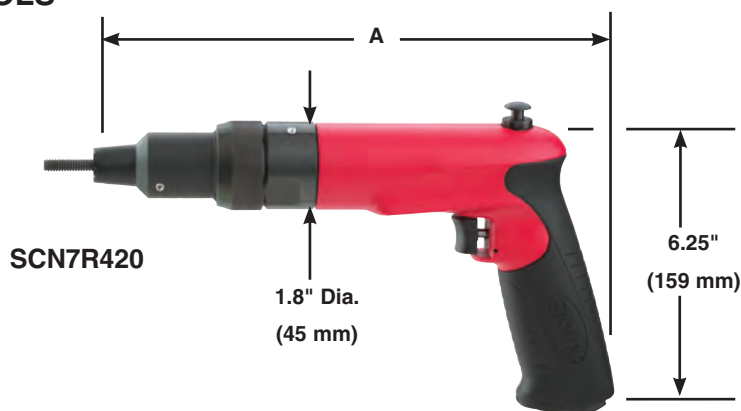

**Performance:**

Torque: 60 in. lb (6.5 Nm) – 400 in. lb (45 Nm)  
 Speed: 300 rpm – 2,500 rpm

**Features:**

Reversible  
 Pistol Grip

**For ordering complete tools** select the appropriate power unit from the power unit table below, then select required thread size from Clinch Nut or Stud Head Unit tables. Combine part numbers for complete tool e.g. 700 rpm + 1/4-20 serrated nose = SCN7R420.

**1 hp (0.75 kW) Clinch Nut Power Unit**



Model Number	Free Speed	Maximum Torque		Weight		"A" Dimension		Side To Center		Maximum Air Consumption		
	rpm	in lb	Nm	lb	kg	in	mm	in	mm	cfm	l/s	
<b>Pistol Grip – Rapid Reverse – Power Unit Only Specifications</b>												
SCN3R	300	400	45.2	3.2	1.5	11	279	0.9	20	30	14	
SCN5R	500	325	36.7	3.2	1.5	11	279	0.9	20	30	14	
SCN7R	700	220	24.8	3.2	1.5	11	279	0.9	20	30	14	
SCN12R	1200	145	16.4	3.2	1.5	11	279	0.9	20	30	14	
SCN20R	2000	80	9.0	2.8	1.3	10	254	0.9	20	30	14	
SCN25R	2500	60	6.5	2.8	1.3	10	254	0.9	20	30	14	

**General:**

Air Inlet Size: 1/4" NPT • Recommended Hose Size: 3/8" (10 mm) • Performance rated @ 90 psig (6.2 bar) air pressure

**Standard Equipment:**

Parts List • Safety and Instruction Manual • Comfort Grip

**Accessories:**

Clinch Nut Accessories, see pages 81 – 82



**Front End Attachments**

**Clinch Nut**



Thread Size	Order Number Suffix	
	Serrated Nose	Smooth Nose
#4-40	440	440S
M3 x 0.5	M305	M305S
#6-32	632	632S
#8-32	832	832S
M4 x 0.7	M407	M407S
#10-24	1024	1024S
#10-32	1032	1032S
M5 x 0.8	M508	M508S
1/4-20	420	420S
M6 x 1.0	M610	M610S
5/16-18	518	518S
M8 x 1.25	M8125	M8125S
3/8-16	616	616S
M10 x 1.5	M1015	M1015S

**Clinch Stud**



Thread Size	Order Number Suffix	
	Serrated Nose	Smooth Nose
#4-40	440F	440SF
M3 x 0.5	M305F	M305SF
#6-32	632F	632SF
#8-32	832F	832SF
M4 x 0.7	M407F	M407SF
#10-24	1024F	1024SF
#10-32	1032F	1032SF
M5 x 0.8	M508F	M508SF
1/4-20	420F	420SF
M6 x 1.0	M610F	M610SF
5/16-18	518F	518SF
M8 x 1.25	M8125F	M8125SF
3/8-16	616F	616SF
M10 x 1.5	M1015F	M1015SF

Head unit assemblies can be ordered separately by adding the prefix SCN to the above part number (example 1/4-20 serrated nose = SCN-420).



**SAFETY PRECAUTION:** Read and follow all safety and operating instructions.  
**WARNING:** Face & eye protection must be worn while operating power tools, per ANSI B186.1



TAPPERS

**Performance:**

Power: 1 hp (0.75 kW)  
 Torque: 145 in. lb (16 Nm) – 400 in. lb (45 Nm)  
 Speed: 300 rpm – 1,200 rpm

**Features:**

Pistol Grip Handle  
 Rapid Reverse

**Capacity:**

1/4" in Steel  
 5/16" in Aluminum



**Tappers**

Model Number	Chuck Capacity		Maximum Torque		Free Speed	Weight		Length		Air Consumption	
	in	mm	in lb	Nm	rpm	lb	kg	in	mm	cfm	l/s
<b>1 hp (0.75 kW) – Pistol Grip – Trigger Start</b>											
STP10P3C20	#10-5/16	5-8	400	45	300	2.9	1.3	7.3	185	30	14
STP10P3C32	1/4-1/2	6-13	400	45	300	2.9	1.3	7.3	185	30	14
<b>1 hp (0.75 kW) – Inline – B12 Taper Spindle</b>											
STP10S12B12			145	16	1200	2.5	1.2	9.5	240	30	14
STP10S7B12			220	25	700	2.5	1.2	9.5	240	30	14
STP10S5B12			325	37	500	2.5	1.2	9.5	240	30	14
STP10S3B12			400	45	300	2.5	1.2	9.5	240	30	14

**General:** Air Inlet Size: 1/4" NPT • Recommended Hose Size: 3/8" (10 mm) • Performance rated @ 90 psig (6.2 bar) air pressure  
**Standard Equipment:** Parts List • Safety and Instruction Manual • Comfort Grip • Tapping Chuck (model STP10P3C series)  
**Accessories:** Tapper Accessories, see pages 81 – 82

**Performance:**

Power: 0.6 hp (0.45 kW) - 1 hp (0.75 kW)  
 Speed: 21,000 rpm

**Features:**

0.0005" Locking Depth Increments  
 Spindle Lock  
 SRS6P E-Z Set and Lock  
 SRS10P Locking Collar with Reference Marks

**Rivet Shavers**

Model Number	Cutter Diameter		Free Speed	Weight		Length		Side to Center		Maximum Air Consumption	
	in	mm	rpm	lb	kg	in	mm	in	mm	cfm	l/s
<b>0.6 hp (0.45 kW) – Pistol Grip – 1/4"-28 Internal Thread</b>											
SRS6P21-5	5/16	8	21000	2.0	0.9	6.5	165	0.8	21	25	12
SRS6P21-6	3/8	10	21000	2.0	0.9	6.5	165	0.8	21	25	12
SRS6P21-7	7/16	11	21000	2.0	0.9	6.5	165	0.8	21	25	12
SRS6P21-8	1/2	13	21000	2.0	0.9	6.5	165	0.8	21	25	12
SRS6P21-9	9/16	14	21000	2.0	0.9	6.5	165	0.8	21	25	12
SRS6P21-10	5/8	16	21000	2.0	0.9	6.5	165	0.8	21	25	12
SRS6P21-9W	9/16	14	21000	2.0	0.9	6.5	165	0.8	21	25	12
<b>1 hp (0.75 kW) – Pistol Grip – 1/4"-28 Internal Thread</b>											
SRS10P21-5	5/16	8	21000	2.7	1.2	8.0	205	0.9	23	25	12
SRS10P21-6	3/8	10	21000	2.7	1.2	8.0	205	0.9	23	25	12
SRS10P21-7	7/16	11	21000	2.7	1.2	8.0	205	0.9	23	25	12
SRS10P21-8	1/2	13	21000	2.7	1.2	8.0	205	0.9	23	25	12
SRS10P21-9	9/16	14	21000	2.7	1.2	8.0	205	0.9	23	25	12
SRS10P21-10	5/8	16	21000	2.7	1.2	8.0	205	0.9	23	25	12
<b>1 hp (0.75 kW) – Inline – 1/4"-28 Internal Thread</b>											
SRS10S21-8	1/2	13	21000	2.5	1.1	10.0	255	0.9	23	30	14

**General:** Air Inlet Size: 1/4" NPT • Recommended Hose Size: 3/8" (10 mm) • Performance rated @ 90 psig (6.2 bar) air pressure  
**Standard Equipment:** Parts List • Safety and Instruction Manual • Skirt • Comfort Grip (Pistol Grip models)  
 Stabilizer (SRS10P) • Cutters Not Included

RIVET SHAVERS



SRS6P21-8



SRS10P21-8



SRS10S21-8



Part Number	Cutter Diameter	
	in	mm
2925-5	5/16	8
2925-6	3/8	10
2925-7	7/16	11
2925-8B	1/2	13
2925-9	9/16	14
2925-9W	9/16	14
2925-10	5/8	16



2925-8B

RIVET SHAVER SKIRTS AND STABILIZER

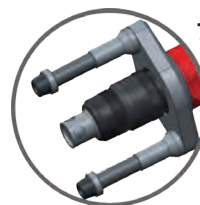

74274A

Part Number	For Use On
74274A	SRS6P21 series



**SAFETY PRECAUTION:** Read and follow all safety and operating instructions.  
**WARNING:** Face & eye protection must be worn while operating power tools, per ANSI B186.1

## SKIN CLAMP RUNNERS



2S2300SR



14S2500R



SSR6P25

### Performance:

Speed: 2,200 rpm - 2,500 rpm

### Features:

Pistol Grip and Z-Handle  
1/2-12 Point Internal, 9/16-6 Point External Hex

### Skin Clamp Runners



Model Number	Fastener Type	Free Speed	Weight		Length		Side to Center		Air Consumption Free Speed	
		rpm	lb	kg	in	mm	in	mm	cfm	l/s
<b>0.20 hp (0.15 kW) – Pistol Grip</b>										
14S2500SR	Cylindrical	2500	1.7	0.7	7.3	185	1.3	33	8	4
<b>0.33 hp (0.25 kW) – Z-Handle</b>										
2S2300SR	Hex	2200	2.6	1.2	5.7	145	0.9	23	16	8
<b>0.40 hp (0.30 kW) – Pistol Grip</b>										
SSR6P25	Hex	2500	2.7	1.2	9.2	234	0.9	23	30	14

**General:** Air Inlet Size: 1/4" NPT • Recommended Hose Size: 3/8" (10 mm) • Performance rated @ 90 psig (6.2 bar) air pressure

**Standard Equipment:** Parts List • Safety and Instruction Manual • Comfort Grip (Pistol Grip models)

**Accessories:** Skin Clamp Runner Accessories, see pages 81 – 82

## RECIPROCATING SAWS

### Performance:

Power: 1 hp (0.75 kW)  
Strokes per Minute: 1,800  
Stroke Length: 0.6" (15 mm)

### Features:

Lockoff Trigger Start  
Variable Speed  
Swivel Air Inlet



1300

### Reciprocating Saw

Model Number	Stroke Length		Strokes per Minute	Power		Weight		Length		Air Consumption	
	in	mm		hp	kW	lb	kg	in	mm	cfm	l/s
1300	0.6	15	1800	1	0.7	7.8	3.5	17.2	437	35	17

**General:** Air Inlet Size: 1/4" NPT • Recommended Hose Size: 3/8" (10 mm) • Performance rated @ 90 psig (6.2 bar) air pressure

**Standard Equipment:** Parts List • Safety and Instruction Manual • Swivel Air Inlet • 10 Blades • Protective Boot

**Accessories:** Reciprocating Saw Accessories, see pages 81 – 82

### Reciprocating Saw Blades

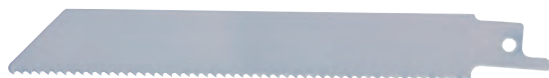

1815



1816



1823

### Reciprocating Saw Blades

Part Number	Length		Teeth Per Inch
	in	mm	
<b>For Use on Model 1300</b>			
1815B	6	150	10
1810	6	150	14
1813	4	100	14
1811	6	150	18
1812	4	100	18
1814	6	150	24
1816	6	150	6
1819	12	300	6

### Air Saw Blades

Part Number	Length		Teeth Per Inch
	in	mm	
<b>For Use on Model RS10K</b>			
1823	3.7	94	18
1824B	3.7	94	24
1825	3.7	94	32

Packaged in Cartons of 5



**SAFETY PRECAUTION:** Read and follow all safety and operating instructions.  
**WARNING:** Face & eye protection must be worn while operating power tools, per ANSI B186.1

RECIPROCATING SAWS

**Performance:**

Strokes per Minute: 10,000  
 Stroke Length: 0.375" (10 mm)  
 Cuts up to 1/8" (3 mm) mild steel

**Features:**

Lock-off lever start  
 Low vibration  
 360° Adjustable Exhaust Deflector  
 Dual chuck accepts: standard air saw blades AND reciprocating saw blades, up to 0.040" thick



RS10K

**Reciprocating Saw**

Model Number	Stroke Length		Strokes per Minute	Weight		Length		Air Consumption	
	in	mm		lb	kg	in	mm	cfm	l/s
RS10K	0.375	10	10000	1.53	0.69	9.4	240	8.4	4.0

**General:**

Air Inlet Size: 1/4" NPT • Recommended Hose Size: 3/8" (10 mm) • Performance rated @ 90 psig (6.2 bar) air pressure

**Standard Equipment:**

Parts List • Safety and Instruction Manual • Swivel Air Inlet • Protective Boot

**Accessories:**

Reciprocating Saw Accessories, see pages 81 – 82

NIBBLER



SNH10S18

**Performance:**

Power: 1 hp (0.75 kW)  
 Capacity: 18 Gauge Cold Rolled Steel

**Nibbler**

Model Number	Capacity (Cold Rolled Steel)	Power		Weight		Length		Side to Center		Maximum Air Consumption	
	in	hp	kW	lb	kg	in	mm	in	mm	cfm	l/s
SNH10S18 <sup>1</sup>	18 Ga	1	0.75	2.65	1.2	8.5	215	0.9	32	30	14

<sup>1</sup> Not CE Certified

**General:**

Air Inlet Size: 1/4" NPT • Recommended Hose Size: 3/8" (10 mm) • Performance rated @ 90 psig (6.2 bar) air pressure

**Standard Equipment:**

Parts List • Safety and Instruction Manual

**Accessories:**

Nibbler Accessories, see pages 81 – 82

SHEARS



SSH10S18

SSH10P18

**Performance:**

Power: 1 hp (0.75 kW)  
 Capacity: 18 Gauge Cold Rolled Steel

**Shears**

Model Number	Capacity (Cold Rolled Steel)	Power		Weight		Length		Side to Center		Maximum Air Consumption	
	in	hp	kW	lb	kg	in	mm	in	mm	cfm	l/s
SSH10S18 <sup>1</sup>	18 Ga	1	0.75	2.75	1.25	11.0	280	0.9	32	30	14
SSH10P18	18 Ga.	1	0.75	2.9	1.3	10.0	255	0.9	22	30	14

<sup>1</sup> Not CE Certified

**General:**

Air Inlet Size: 1/4" NPT • Recommended Hose Size: 3/8" (10 mm) • Performance rated @ 90 psig (6.2 bar) air pressure

**Standard Equipment:**

Parts List • Safety and Instruction Manual • Comfort Grip (SSH10P18)

**Accessories:**

Shears Accessories, see pages 81 – 82



**SAFETY PRECAUTION:** Read and follow all safety and operating instructions.  
**WARNING:** Face & eye protection must be worn while operating power tools, per ANSI B186.1

# SPECIALTY

## Compression Riveters

### Principles of Operation

Air powered compression riveters deliver a squeezing action, which drives the rivet by “flowing” the rivet metal with compressed forces. Squeezing action is obtained by coupling an air cylinder and piston to a wedge or cam, thus multiplying the original force to extreme ratios. High compressive forces are obtained from a relatively compact unit having small diameter cylinders and using very little compressed air.

The advantage of squeeze riveting is simple sounds of air exhaust and forward piston movement developing tremendous pressures being exerted at the work point.

Optimum control may be obtained in compression riveting. The rivet head is formed by a steady, uniform squeeze action. The set plunger and dolly are an integral part of the squeezer itself.

Length of the return stroke may be adjusted that the plunger itself does not have to travel its full length.

Consistently applied pressure makes for a better appearance of the finished product as well as giving the ultimate in structural efficiency.

### Classification of Squeezers:

Alligator: The squeezing action of the jaws are similar to the movement of an Alligator's jaws.

‘C’ Type: The rivet is squeezed between the two ends of the ‘C’.

#### Type of Rivet:

Rivet material.

Rivet body diameter.

Rivet length before and after compression.

Force required to compress rivet.

#### Riveter Selection Guide:

What material is the rivet made from?

What size is the rivet?

What is the form of the head?

What components are being assembled?

Are there any clearance problems?

Is Alligator or ‘C’ type yoke required?

How is the application being done now?

Are there any special considerations?

### COMPRESSION RIVETERS

For maximum power the combined length of the two rivet sets must be of the correct length.

Determine the correct lengths as follows:

#### 1) When two cupped rivet sets are used:

The length of the body dimensions of the two rivet sets (A1, A2) should equal the closed height dimension of the yoke (H) minus the total thickness of material being riveted together.

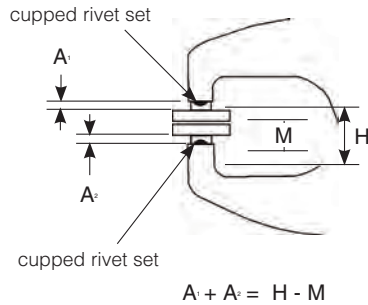

#### 2) When one cupped set and one flush set are used:

The length of the body dimensions of the two rivet sets (A1, A2) should equal the closed height dimension of the yoke H minus the total thickness of material being riveted (M) and the height of the finished rivet head (Z) compressed by the flush set (A).

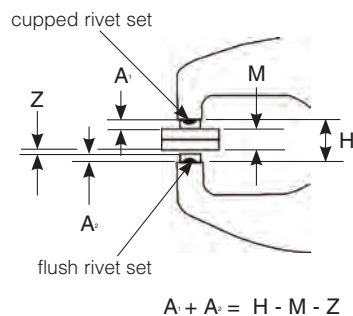

#### 3) When two flush sets are used:

The length of the body dimensions of the two rivet sets (A1, A2) should equal the closed height dimension of the yoke (H) minus the overall length of the rivet (M) after it is compressed.

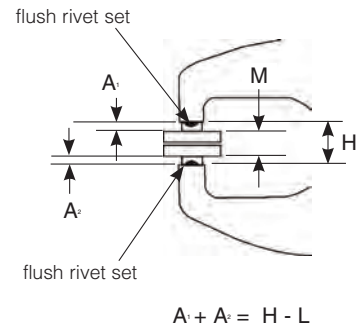

If necessary, select rivet sets a little short and shim to the correct length using spacer shims.

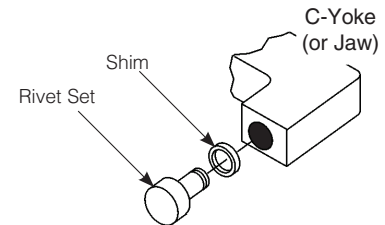



COMPRESSION RIVETERS

Features:

- Single, Tandem, and Triple Cylinder Options
- Riveting Capacity:
  - 1/8" (3 mm) (Single Cylinder)
  - 3/16" (5 mm) (Tandem Cylinder)
  - 1/4" (6 mm) (Triple Cylinder)
- Safety Throttle



Compression Riveters

Model Number	Rivet Set Shank Diameter		Cap Cold Rivet Diameter				Standard Alligator Yoke Dimension				Max Force at 90 psi		Moving Jaw				Net Weight w/ Yoke		Overall Length	
			Steel		Alum		Reach		Closed Ht				Max Travel		Stroke at Max Force					
	in	mm	in	mm	in	mm	in	mm	in	mm	in	mm	in	mm	in	mm	lb	kg	in	mm
<b>CR-1 – Single Cylinder</b>																				
SZEA5000	NA	NA	3/32	2	1/8	3	NA	NA	NA	NA	3000	13.4	5/8	16	final 1/16	2	2-1/4	1.0	7-11/16	195
SZEA5015	3/16	5	3/32	2	1/8	3	1-1/2	38	7/8	22	3000	13.4	5/8	16	final 1/16	2	3.75	1.7	9-3/16	233
SZEA5022	3/16	5	3/32	2	3/32	2	2-1/4	57	7/8	22	2200	9.8	7/8	22	final 3/32	2	4.25	1.9	10-1/8	257
SZEA5030	3/16	5	3/32	2	3/32	2	3	76	7/8	22	1800	8.0	1-1/4	32	final 1/8	3	4.75	2.2	10-7/8	276
<b>CR-1 – Tandem Cylinder</b>																				
SZEA7000	NA	NA	5/32	4	3/16	5	NA	NA	NA	NA	6000	26.7	5/8	16	final 1/16	2	4.0	1.8	10-1/2	267
SZEA7015	3/16	5	5/32	4	3/16	5	1-1/2	38	7/8	22	6000	26.7	5/8	16	final 1/16	2	5.5	2.5	12	305
SZEA7022	3/16	5	1/8	3	5/32	4	2-1/4	57	7/8	22	4300	19.1	7/8	22	final 3/32	2	6.0	2.7	13	330
SZEA7030	3/16	5	3/32	2	1/8	3	3	76	7/8	22	3400	15.1	1-1/4	32	final 1/8	3	6.25	2.8	13.75	349
<b>CR-1 – Triple Cylinder</b>																				
SZEA9000	NA	NA	3/16	5	1/4	6	NA	NA	NA	NA	9000	40.1	5/8	16	final 1/16	2	5.5	2.5	14.5	368
SZEA9015	3/16	5	3/16	5	1/4	6	1-1/2	38	7/8	22	9000	40.1	5/8	16	final 1/16	2	7.0	3.2	16	406
SZEA9022	3/16	5	5/32	4	3/16	5	2-1/4	57	7/8	22	7000	31.2	7/8	22	final 3/32	2	7.5	93.4	16.75	426
SZEA9030	3/16	5	5/32	4	3/16	5	3	76	7/8	22	5200	23.1	1-1/4	32	final 1/8	3	8.0	3.6	17.5	445

General:

Air Inlet Size: 1/4" NPT • Recommended Hose Size: 3/8" (10 mm) • Performance rated @ 90 psig (6.2 bar) air pressure

Standard Equipment:

Parts List • Safety and Instruction Manual • Safety throttle action

Alligator Yoke Nomenclature

- A** Reach
- B** Closed Height
- C** Total
- E** Gap
- H** Lowest Offset
- N** Depth from centerline to Stationary Jaw Gap
- P** Depth from centerline to Stationary Jaw set hole surface

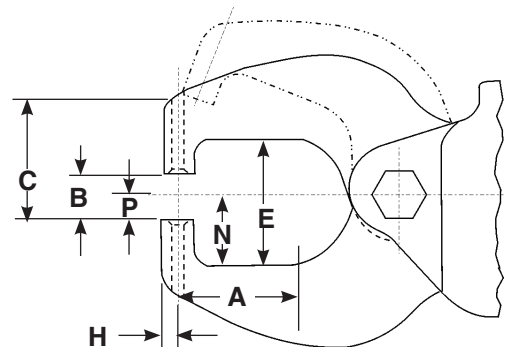

A		B		C		E		H		N		P	
in	mm	in	mm	in	mm	in	mm	in	mm	in	mm	in	mm
1-1/2	38	7/8	22	1-1/2	38	1-5/8	41	7/32	6	1.0	1	5/8	16
2-1/4	57	7/8	22	1-7/8	48	2-1/8	54	7/32	6	1-1/4	32	5/8	16
3	76	7/8	22	2-1/8	54	2-1/8	54	7/32	6	1-1/4	32	5/8	16



**SAFETY PRECAUTION:** Read and follow all safety and operating instructions.  
**WARNING:** Face & eye protection must be worn while operating power tools, per ANSI B186.1

## COMPRESSION RIVETERS

### Features:

Single, Tandem, and Triple Cylinder Options

Riveting Capacity:

1/8" (3 mm) (Single Cylinder)

3/16" (5 mm) (Tandem Cylinder)

1/4" (6 mm) (Triple Cylinder)

Safety Throttle



SZE3015



SZE6015



SZE8015

### Compression Riveters

Model Number	Rivet Set Shank Diameter		Cap Cold Rivet Diameter				Standard "C" Yoke Dimension				Closed Height		Max Travel		Max Force at 90 psi		Stroke at Max Force		Net Weight w/ Yoke		Overall Length	
			Steel		Alum		Reach		Gap													
	in	mm	in	mm	in	mm	in	mm	in	mm	in	mm	in	mm	lb	kN	in	mm	lb	kg	in	mm
<b>CR-1 – Single Cylinder</b>																						
SZE3000	N/A	N/A	3/32	2	1/8	3	N/A	N/A	N/A	N/A	N/A	N/A	9/16	14	3000	13.4	f-1/16	2	3-1/2	1.6	8-1/2	216
SZE3015	3/16	5	3/32	2	1/8	3	1-1/2	38	1-1/4	32	11/16	78	9/16	14	3000	13.4	f-1/16	2	4-1/2	2	10-1/4	262
<b>CR-1 – Tandem Cylinder</b>																						
SZE6000	N/A	N/A	5/32	4	3/16	5	N/A	N/A	N/A	N/A	N/A	N/A	9/16	14	6000	26.7	f-1/16	2	4-1/2	2	11-1/4	287
SZE6015	3/16	5	5/32	4	3/16	5	1-1/2	38	1-1/4	32	11/16	78	9/16	14	6000	26.7	f-1/16	2	5-1/2	2.5	14	356
<b>CR-1 – Triple Cylinder</b>																						
SZE8000	N/A	N/A	5/32	4	1/4	6	N/A	N/A	N/A	N/A	N/A	N/A	9/16	14	9000	40.1	f-1/16	2	7-1/2	3.4	16	406
SZE8015	3/16	5	3/16	5	1/4	6	1-1/2	38	1-1/4	32	11/16	78	9/16	14	9000	40.1	f-1/16	2	8-1/2	3.9	18-3/4	476

Due to a variety of jobs and applications, Squeeze Riveters are not supplied with rivet sets.

Please contact Sioux Tools, Inc. or your local distributor for rivet set information.

#### General:

Air Inlet Size: 1/4" NPT • Recommended Hose Size: 3/8" (10 mm) • Performance rated @ 90 psig (6.2 bar) air pressure

#### Standard Equipment:

Parts List • Safety and Instruction Manual • Safety throttle action

## C-Yoke Nomenclature

- A** Reach
- B** Gap
- C** Height from yoke hole to center to top of yoke gap
- D** Bottom set hole diameter CR-1 or CR-2
- E** Top set hole diameter CR-1 or CR-2
- F** Width of yoke set hole center to top of yoke
- G** Thickness of yoke
- H** Height of yoke from bolt hole center to top of yoke
- I** Radius from set hole center

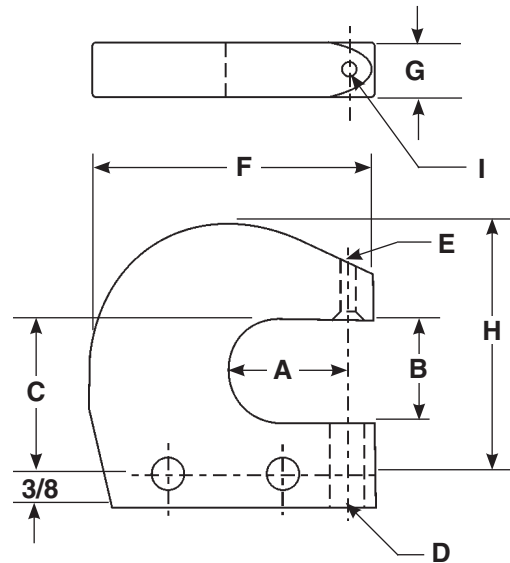

A		B		C		D		E		F		G		H		I	
in	mm	in	mm	in	mm	in	mm	in	mm	in	mm	in	mm	in	mm	in	mm
1-1/2	38	1-1/4	32	1-7/8	48	3/8	10	3/16	5	2-7/8	73	9/16	14	3	76	1/4	6
						7/16	11	1/4	6								



**SAFETY PRECAUTION:** Read and follow all safety and operating instructions.  
**WARNING:** Face & eye protection must be worn while operating power tools, per ANSI B186.1

**Rivet Shaver Skirts**



Part Number	Cutter Diameter	
	in	mm
2925-5	5/16	8
2925-6	3/8	10
2925-7	7/16	11
2925-8B	1/2	13
2925-9	9/16	14
2925-9W	9/16	14
2925-10	5/8	16

**Stabilizer**

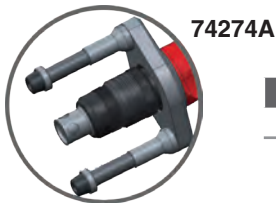

Part Number	For Use On
74274A	SRS6P21 series

**Collets**



Collet Type	Part Number	Capacity	For Use On
Sioux	44440	1/4"	1971HP series
Sioux	66038	6 mm	1971HP series
100 Series	21126B	1/4"	1980A, 1982A, RT1985
100 Series	21125	3/8"	1980, RT1982, 1985A
100 Series	21124	1/2"	1981F, RT1981, RT1983, 1985-1/2



Collet Type	Collets
21095	#10 - 5/16"
21139	1/4" - 1/2"

**Signature Series Support Handle**

**Part No. 77067A**

For use on 10P and 10S tools.



**Collet Chuck Assemblies**

**Sioux Style Collets**

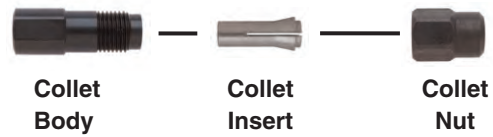

Collet Chuck Assemblies	Sioux Collet Chuck				
	1/8"	3 mm	3/16"	1/4"	6 mm
Chuck Assembly	43342	68617	43341	43340	68618
Collet Body	21096	21096	21096	21096	21096
Collet Insert	44522	66037	44523	44440	66038
Collet Nose	N/A	N/A	N/A	N/A	N/A
Collet Nut	21097	21097	21097	21097	21097

**200 Series Heavy Duty Double Tapered Collet**



Part Number	Description
74071	Collet Nut
74072	Collet (1/8")
74073	Collet (3/16")
74074	Collet (1/4")
77400	Collet (1/4") Heavy Duty
68030	Collet (3/8")
74075	Collet (3 mm)
74076	Collet (6 mm)
68056	Collet (8 mm)
77057	Collet Body SDG Series
74070	Collet Body (1 hp)
74070KIT	Includes 74070, 74071, 74074

**300 Series Heavy Duty Double Tapered Collet**



Part Number	Description
74128	Collet Nut
74124	Collet (3/32")
74121	Collet (1/8")
74120	Collet (1/4")
74122	Collet (3 mm)
74123	Collet (6 mm)
77505	Collet Body SAS Series
74125	Collet Body SDG Series



**SAFETY PRECAUTION:** Read and follow all safety and operating instructions.  
**WARNING:** Face & eye protection must be worn while operating power tools, per ANSI B186.1

**Router Base Assembly**

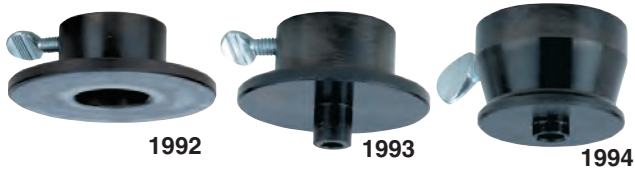

Part Number	Used On
1992	SRT10S25BB
1993	1971HP / SRT10S25BB
1994	1971HPC / SRT10S25BB

**Laminate Base Trimmer**

**Part No. 1991**

For use on SRT10S25LT series routers



**Reciprocating Saw Blades**

Packaged in Cartons of 5



1815



1816

Part Number	Length		Teeth Per Inch
	in	mm	
<b>For Use on Model 1300 &amp; RS10K</b>			
1815B	6	150	10
1810	6	150	14
1813	4	100	14
1811	6	150	18
1812	4	100	18
1814	6	150	24
1816	6	150	6
1819	12	300	6



1823

Part Number	Length		Teeth Per Inch
	in	mm	
<b>For Use on Model RS10K</b>			
1823	3.7	94	18
1824B	3.7	94	24
1825	3.7	94	32

**Template Guide Chart**

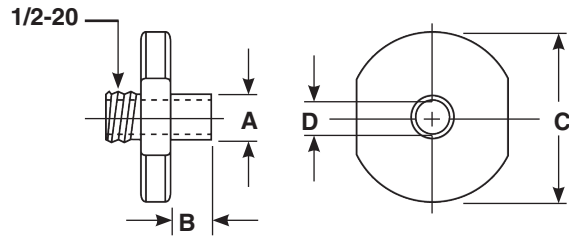

Part Number	Dimensions in Inches			
	A Pilot OD	B Pilot Length	C Flange OD	D Pilot ID
68613-12	3/8	1/4	3/4	9/32
68613-14	3/8	3/8	3/4	9/32
68613-16	3/8	1/2	3/4	9/32
68613-22	3/8	1/8	1-1/2	9/32
68613-24	3/8	1/4	1-1/2	9/32
68613-26	3/8	3/8	1-1/2	9/32
68613-40	7/16	1/4	3/4	21/64
68613-42	7/16	3/8	3/4	21/64
68613-44	7/16	1/2	1-1/2	21/64
68613-48	7/16	1/4	1-1/2	21/64
68613-50	7/16	3/8	1-1/2	21/64
68613-52	7/16	1/2	1-1/2	21/64
68613-62	1/2	1/4	1-1/2	11/32
68613-64	1/2	3/8	1-1/2	11/32
68613-66	1/2	1/2	1-1/2	11/32
68613-72	1/2	1/2	2-1/2	11/32



**SAFETY PRECAUTION:** Read and follow all safety and operating instructions.  
**WARNING:** Face & eye protection must be worn while operating power tools, per ANSI B186.1



### Filter, Regulator, Lubricator Assembly

**Part No. 1660B**

1/2" NPT fittings  
Air Flow: 30 – 75 cfm



Part Number	Description
1660B	Complete Air Control Unit, 1/2" PT
1661	Lubricator Only, 1/2" PT
1662A	Regulator with Gauge, 1/2" PT
1663	Manual Flex Drain Filter, 1/2" PT
1667	Automatic Drain – Optional

### Filter, Regulator, Lubricator Assembly

**Part No. 1651MA**

3/4" NPT air fittings  
Air Flow: Over 75 cfm



Part Number	Description
1651MA	Complete Automatic Air Control Unit, 3/4" PT, larger capacity and float type filter for automatic drain
1652M	Lubricator only, 3/4" PT, 1 quart capacity
1654B	Regulator with Gauge, 3/4" PT
1653MA	Automatic Air Filter, 3/4" PT, automatic float drain empties when full

### Air Regulator

**Part No. 1335B**

- 1/4" NPT Male/Female
- Mounts inline with air inlet
  - Allows fine adjustment of air flow



### Hi-Capacity Quick Change Couplers

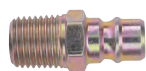

1316



1391



1395

Part Number	Description	Thread
1316	Male Coupler Nipple	1/4" NPT
1317	Male Coupler Nipple	3/8" NPT
1318	Male Coupler Nipple	1/2" NPT
1391B	Quick Change Coupler	1/4" NPT
1392B	Quick Change Coupler	3/8" NPT
1393	Quick Change Coupler	1/2" NPT
1395	Female Coupler Nipple	1/4" NPT
1396	Female Coupler Nipple	3/8" NPT

### Nylon Recoil Air Hose



1326

Part Number	ID		Length		Fittings
	in	mm	ft	m	
1326B	1/4	6	25	7.6	1/4" NPT
1327B	3/8	10	25	7.6	1/4" NPT

### Sioux Swivel

Allows the air hose to rotate 360° on 2 axes.



Part Number	Description
1338-25	1/4" non-regulated air swivel connector with safety pin
1338-38	3/8" non-regulated air swivel connector with safety pin
1338-50	1/2" non-regulated air swivel connector with safety pin
1338FC-25	1/4" regulated air swivel connector with safety pin

### Balancers



2300-4

Part Number	Capacity		Cable Length	
	lb	kg	ft	m
2300-4	2 - 4	0.9 – 1.8	6.7	2
2300-6	4 - 6	1.8 – 2.7	6.7	2
2300-8	6 - 8	2.7 – 3.6	6.7	2



**WARNING**



**SAFETY PRECAUTION:** Read and follow all safety and operating instructions.  
**WARNING:** Face & eye protection must be worn while operating power tools, per ANSI B186.1

**Grease Gun**

**Part No. 439**

Use with impact wrenches and multi-assembly angle tools. For use with grease tube 1232A-04.



**Grease Nozzle**

**Part No. 469A**

Used with No. 468A grease gun.



**Grease**

Part Number	Description
289A	1 Quart
289A-1	2 Pounds
289A-2	6 Pounds
1198	6 Ounces
1198-1	2 Pounds
1198-2	6 Pounds
1232A-04	4 Ounces
1232A-1	1 Quart

**Air Motor Oil For Air Tools**

**Part No. 288**

1/2 Pint

**Part No. 288-1**

1 Quart

**Part No. 288-2**

2 Liter



**SAFETY PRECAUTION:** Read and follow all safety and operating instructions. **WARNING:** Face & eye protection must be worn while operating power tools, per ANSI B186.1

# Service

## Factory Authorized Service

Sioux Tools has Authorized Service Distributors conveniently located throughout the U.S., Canada and internationally to provide you with service virtually anywhere, anytime. Each is staffed with professional tool repair technicians who know Sioux tools, inside and out, and are able to provide complete and comprehensive repairs.

Each location features the newest in testing and inspection equipment to ensure your tool is repaired and serviced properly...the first time. Every tool that is serviced or repaired is calibrated and tested to the latest standards guaranteeing you the best performance possible.

See inside back cover for a complete listing of Authorized Service Distributors.

# Training

## Committed to your Success

To ensure your personnel are knowledgeable about not only Sioux products, but all air tools and products, Sioux Tools conducts training seminars that cover all aspects of the tools we sell. We offer introductory training seminars to help you understand our entire line of tools and their basic operation. Advanced training is tailored to individual needs to help build the skill of an experienced student. In addition, hands-on training is available with particular focus on troubleshooting and repairing.

For additional information on Sioux Tools training seminars, please contact your Sioux Tools Sales Representative.



*Our 168,000 ft<sup>2</sup> facility in Murphy, North Carolina employees 300 associates. Each tool is designed and manufactured right here, with a distribution center that ships daily around the globe.*



Murphy, NC



# U.S. Independent Service Centers

## ALABAMA

### Birmingham

Motion Industries  
824 North 31st Street  
35203  
205-251-7522

### Birmingham

Tool Smith Company, Inc.  
1300 Fourth Ave S  
35233  
205-323-2576  
800-317-8665

### Dothan

Brackin Wholesale Coatings  
725 South Oates St  
36301  
334-793-4330

### Winfield

McCaleb Tool Supply  
710 Hwy 43 South  
35594  
205-487-2222

## ARIZONA

### Phoenix

Glenn's Tool Service  
2149 East Indian School Rd  
85016  
602-264-6203

## ARKANSAS

### Hot Springs

Arkansas Welding, Inc.  
230 Valley St.  
71901  
501-321-9922

## CALIFORNIA

### Buena Park

Three Day Tool, Inc.  
6767 8th Street  
90620  
714-521-9180

### Rancho Dominguez

U.S. Air Tool Company  
1219 W. Mahalo Pl.  
90220  
310-632-5400

## COLORADO

### Denver

AIS Industrial & Construction Supply  
3900 Ulster Street  
80207  
303-355-2391

## FLORIDA

### Doral

Air/Electric Tool & Equipment  
7840 Nw 58th St  
33166  
305-593-5040

### Jacksonville

World Electric Supply, Inc.  
569 Stuart Lane  
32254  
904-378-4000

### Orlando

Air Centers of FL  
7830 Kingspointe Parkway  
32819  
407-677-4200

### Port Charlotte

Tropical Construction Supply  
18412 Paulson Dr  
33954  
941-743-5863

### Spring Hill

R & R Tool Repair, Inc.  
13591 Linden Dr  
34609  
352-263-3587

### Tampa

Compressed Air Systems, Inc.  
9303 Stannum Street  
33619  
800-626-8177

## GEORGIA

### Atlanta

Fastenal  
6215 Fulton Industrial Blvd.  
30336  
404-346-1026

### Snellville

Kentec Inc.  
3250 Centerville Hwy  
30039  
770-985-1907

## IOWA

### Bloomfield

Gingerich Logging & Supply  
16700 Jade Ave  
52537  
515-830-4414

### Des Moines

Peerless Supply Inc.  
1701 Guthrie Ave  
50316  
515-265-9905

### Sioux City

The Sioux City Iron Co.  
310 South Floyd  
51101  
712-255-7696  
800-831-2211

## ILLINOIS

### Machesney Park

Engman-Taylor Co Inc.  
7980 Burden Rd  
61115  
800-236-7282

### Mattoon

S & K Air Power  
317 Dewitt Ave East  
61938  
217-258-8500

## INDIANA

### Elkhart

Alco Tool Supply Inc.  
54847 County Rd 17  
46515  
574-295-5535

### Evansville

Lensing Tool & Supply  
306 No 7th Ave  
47730  
812-425-9049

### Ferdinand

Superb Tooling, Inc.  
250 Scenic Industrial Dr.  
47532  
812-367-2102

### Fort Wayne

Mill Supplies Inc.  
5105 Industrial Road  
46825  
260-484-8566

### Indianapolis

Alcorn Industrial Inc.  
5412 Rock Hampton Court  
46268  
317-872-6772

### Indianapolis

Fastenal  
3939 W 56th St  
46254  
317-472-4341

### Indianapolis

Vamaco Tool & Equipment Co.  
6718 East 38th Street  
46226  
317-632-2208

## KANSAS

### Edwardsville

Fastenal  
9911 Woodend Rd  
66111  
913-422-6469

### Wichita

Four State Industrial Supply  
1731 S. Eisenhower Ct.  
67209  
316-558-8225

## KENTUCKY

### Louisville

Rhino Assembly Service Center  
3600 Chamberlin Ln., Suite 618  
40214  
502-753-0602

## LOUISIANA

### New Orleans

Beerman Precision Inc.  
4206 Howard Ave  
70125  
504-486-9391

## MASSACHUSETTS

### Everett

Panda Electrical Service  
165 Main St  
02149  
617-389-1442

## MINNESOTA

### Bloomington

Mars Supply  
215 E. 78th Street  
55420  
952-884-9388  
800-862-6093

### Duluth

Mars Supply  
4319 W. 1st Street  
55807  
218-628-0303

### Little Falls

Central McGowan  
16444 11th St. NE  
56345  
320-632-9218

### Minneapolis

Deko Factory Service  
3048 Bloomington Ave So  
55407  
612-721-6651

### Winona

Fastenal  
2003 Theurer Blvd  
55987  
507-313-7527

## MISSOURI

### Blue Springs

Clark's Tool Repair  
815-17 SW US Hwy 40  
64015  
816-228-9885

### Berkeley

John Henry Foster  
4700 LeBourget Dr.  
63134  
314-593-1203

### Fenton

Productive Tool Products, Inc.  
1075 Headquarters Park Dr  
63026  
636-305-1202

### Saint Louis

Logan Gresham, Ltd  
9 South Florissant Rd  
63135  
314-521-2400

## MISSISSIPPI

### Tupelo

Compressors & Tools Inc.  
105 Old Runway Rd  
38801  
662-844-7023

## NORTH CAROLINA

### Belmont

IDG  
2100 The Oaks Parkway  
28012  
704-398-5600

### Greensboro

Carolina Tool Sales And Repair, Inc.  
807 Huffman St  
27405  
336-275-6124



# U.S. Independent Service Centers

## High Point

Air Power, Inc. (NC)  
1430 Trinity Avenue  
27260  
336-886-5081

## High Point

Fastenal  
4110 Premier Dr  
Suite 102  
27265  
336-888-3013

## High Point

High Point Pneumatics Inc.  
2430 English Rd  
27262  
336-889-8416

## NEBRASKA

### Omaha

JDC Tool & Repair  
6263 Abbott Dr  
68110  
402-455-6151

### Omaha

Thacker Electric  
8517 I Street  
68127  
402-592-9433

## NEW YORK

### Syracuse

Ace Hydralic & Pneumatic  
6720 Vip Parkway  
13211  
315-454-8989

## OHIO

### Apple Creek

Air Works  
10680 Dover Rd.  
44606  
330-698-0388

### Cleveland

Industrial Pneumatic  
1715 Brookpark Rd.  
44109  
216-398-7550

### Columbus

Mitchell-Mckinney Supply Co.  
610 Greenlawn Ave  
43223  
614-444-6732

### Richfield

Ohio Tool Systems  
3863 Congress Parkway  
44286  
330-659-4181

### Youngstown

Power Tool & Supply Co.  
3699 Leharps Rd  
44515  
330-792-1487

## OKLAHOMA

### Tulsa

Tool Center Inc.  
1447 North Yale  
74115  
918-838-7411

## OREGON

### Portland

Chas H Day Co, Inc.  
602 So East 11th  
97214  
503-232-1659

## PENNSYLVANIA

### Christiana

Beiler's Pneumatics  
718 Vintage Rd  
17509  
610-593-7064

### Jessup

Fastenal  
1225 Mid Valley Dr.  
18434  
570-307-0992

### Myerstown

Keystone Air Power  
60 Elco Drive  
17067  
717-866-9224

### Robesonia

Rowe Sales & Services, Inc.  
381 West Penn Ave  
19551  
610-693-4031

## TENNESSEE

### Chattanooga

Production Tool Systems Inc.  
2100 S Holtzclaw Ave  
37407  
423-629-6822

### Jackson

Compressors & Tools Inc.  
109 Anglin Lane  
38301  
731-421-8068

### Johnson City

Summers Hardware & Supply Co.  
400 Buffalo Street  
37604  
423-461-4700

### Memphis

DBH Distributors, Inc.  
3325 Millbranch Rd.  
38116  
901-348-1155

### Memphis

Pro Power, Inc.  
7531 Bartlett Corp Cove E,  
Suite 101  
38133  
901-383-7888

## TEXAS

### Denton

Fastenal  
3833 Airport Rd.  
76207  
940-483-8667

### Fort Worth

Wesco Aircraft  
6701 Will Rogers Blvd.  
76140  
817-551-2258

## Longview

Texas Air Hydraulic Service & Sup  
251 S Eastman Rd  
75602  
903-757-8211

## Nederland

ATSCO (Associated Tool  
Specialties Company)  
3711 North Twin City Hwy  
77627  
409-727-2166

## UTAH

### Salt Lake City

Gustin Hydraulics, Inc.  
151 W. Commonwealth Ave  
84115  
801-487-0624

## VIRGINIA

### Portsmouth

Hydraulic Service Co.  
3215 Victory Blvd  
23702  
757-487-2513

### Richmond

Kaman Industrial  
10402 Lakeridge Pkwy #100  
Ashland  
23005  
804 355 8041

### Roanoke

Stultz Mach Tools & Equip Inc.  
1546 Brownlee Ave SE  
24014  
540-981-9359  
800-542-5747

### Salem

C & C Assembly  
2636 West Main St  
24153  
540-904-6416

## WEST VIRGINIA

### Bluefield

Larry's Pneumatic Service, LLC  
100 Princeton Ave  
24701  
304-325-9262

## WISCONSIN

### Green Bay

Power Tool Service Co.  
1180 Ashwaubenon St  
54304  
920-437-2594

### Menomonee Falls

Engman-Taylor Co Inc.  
W142 N9351 Fountain Blvd  
53051  
800-236-1975

### Racine

Machinery & Factory  
1021 Sixth St  
53403  
262-634-3381

## Canadian Independent Service Centers

### ALBERTA

#### Edmonton

Quality Tool Repair  
11420-156 Street  
T5M 3N2  
780-702-1686

#### Spruce Grove

Axis Torque Ltd  
302 Commerce Rd. N.  
T7X 3A5  
780-962-4499

### MANITOBA

#### Winnipeg

Accutool Service Center  
532 Berry St.  
R3H 0R9  
204-772-6523

### NEWFOUNDLAND

#### St. John's

Rideout Tool & Machine Inc  
222 Kenmount Road  
A1B 3R2  
709-754-2240

### NOVA SCOTIA

#### Dartmouth

Rideout Tool & Machine Inc  
170 Akerley Blvd.  
B3B 1Z5  
902-468-2060

### ONTARIO

#### Brampton

Grip Clinch Canada  
73 Ward Rd.  
M9W 6P3  
416-742-9161

### QUEBEC

#### St. Laurent

Phoenix Inc.  
5600 Vanden Abeels  
H4S 1P9  
514-334-5152

#### Trois Rivieres

Outil Mag  
2415 Rue De La Sidbec Sud.  
G8Z 4M6  
819-370-4848

### SASKATCHEWAN

#### Regina

All Tool Repairs  
3100 - 12th Ave  
S4T 1J7  
306-352-1756

## Latin America Independent Service Centers

### ARGENTINA

Assembly S.R.L.  
Brazin 1313 P.B. 4  
Capital Federal 1154  
Buenos Aires  
Argentina  
Phone: (54-1) 304-7390

### BOLIVIA

Herracruz Importaciones  
Av. Roca Y Coronado # 295  
Santa Cruz de La Sierre  
Bolivia  
Sebra  
Phone: (591) 335-41073

### BRAZIL

Sebra  
Snap-on-Latin  
American/Caribbean Division  
Rua Juscelino Kubitschek de  
Oliveira 470  
Distrito Industrial II  
Santa Barbara D' Oeste  
CEP 13456-401 SP  
Brazil  
Phone: (55-19) 2108-1000

### CHILE

Perfect Technology Chile S.A.  
Av. Americo Vespucio  
Norte 2880, Of 505  
El Cortijo, Conchali  
Santiago  
Chile  
Phone: (56-2) 362-1153

### COLUMBIA

Servitools LTDA  
Carrera 58 Mp 14 - 14,  
Zona Industrial Puente  
Bogota  
Colombia  
Phone: (57-1) 420-3599

### ECUADOR

Najomez  
Mosquera Narvaez 746 y  
Carvajal  
Quito  
Ecuador  
Phone: (562) 2359845

### HONDURAS

Herramientas la Atlantica  
2da. Calle, 17 Ave. N.E.  
Col. Universal  
Carretera Vieja a La Lima  
San Pedro Sula  
Honduras  
Phone: (504) 557-6314

### MEXICO

RC Maquinarias S.A. de CV  
Calzada Ignacio Zaragoza  
N° 377  
Col. San Pedro  
Puebla, Pue  
Mexico  
Phone: (52-222) 222-2587

RC Maquinarias S.A. de CV  
Subsidiary  
Calle Diego Rivera N° 39  
Privada Diego Rivera  
Col. Los Alcanfores C.P. 76150  
Queretaro, Que  
Mexico  
Phone: (52-442) 217-7435

Snap-on S un De Mexico,  
S.A. de C.V.  
Av Gustavo Baz, No. 166B  
Colonia La Escuela  
Tlalnepantla, Edo de Mixico  
Mexico 54090  
Phone: (52-55) 5010-3000  
www.snapon.com.mx

Snap-on Sun De Mexico,  
S.A. de C.V.  
Gustavo Baz No 180-F  
Tlalnepantla, Edo. de Mex.  
CP 54090  
Phone: (55) 5010 3060  
contactanos@snapon.com

### NICARAGUA

Sistemas de  
Seguridad Buhler S.A.  
Contiguo donde fue  
Cine Dorado  
Bolonía, Managua  
Nicaragua  
Phone: (505) 2222-6833

### PARAGUAY

H Petersen  
Av. Artigas 1552  
Asuncion  
Paraguay  
Phone: (595-21) 202-615

### PERU

Energotec S.A.  
Calle Los Plasticos 204  
Ate- Lima 3  
Peru  
Phone : (51-1) 348-7570  
Igardí Herramientas S.A.  
Av. Javier Prado (FSTE) #1131  
Lima  
Peru  
Phone : (30-5) 887-3533

### VENEZUELA

Refiteca  
Calle E. Boleita Norte  
Edificio Alexandro  
Local A. Semisotano  
Caracas  
Venezuela  
Phone: (58-212) 235-8042  
Hermaco  
Av. Intercomunal N° 428  
Ciudad Ojeda  
Estado Zulia  
Venezuela  
Phone : (58-65) 260-994

## UK and Europe Independent Service Centers

### UK

Snap-on Tools LTD Repair Centre  
Telford Way Industrial Estate  
Kettering, Northants  
NN168 PU, Great Britain  
Phone: 011-44-1536-413903

### POLAND

Tri Color Industrial  
Ojcowska 110  
Cracow 31-344  
Phone: (48) 12-642-27-23

### THE NETHERLANDS

JCO Tools en Services  
Berkenblad 19  
3233 SR Oostvoorne  
(Zuid-Holland)  
Phone: (31) (0) 657829507

# SIOUX TOOLS INDUSTRIAL CATALOG | CONVERSION CHART

INCH / DECIMAL / MILLIMETER			MILLIMETERS / INCHES				FOOT POUNDS		NEWTON METERS	
1/64	.0156	0.397	26	1.0236	94	3.7008				
1/32	.0312	0.794	27	1.0630	95	3.7402	18	24.4	85	115.2
	.0394	1.000	28	1.1024	96	3.7795	19	25.8	86	116.6
3/64	.0469	1.191	29	1.1417	97	3.8189	20	27.1	87	117.9
1/16	.0625	1.587	30	1.1811	98	3.8583	21	28.4	88	119.3
5/64	.0781	1.984	31	1.2205	99	3.8976	22	29.8	89	120.7
	.0787	2.000	32	1.2598	100	3.9370	23	31.2	90	122.0
3/32	.0937	2.381	33	1.2992	110	4.3307	24	32.5	91	123.4
7/64	.1094	2.778	34	1.3386	120	4.7244	25	33.9	92	124.7
	.1181	3.000	35	1.3780	130	5.1181	26	35.3	93	126.0
1/8	.1250	3.175	36	1.4173	140	5.5118	27	36.6	94	127.4
9/64	.1406	3.572	37	1.4567	150	5.9055	28	38.0	95	128.8
5/32	.1562	3.969	38	1.4961	160	6.2992	29	39.3	96	130.2
	.1575	4.000	39	1.5354	200	7.8740	30	40.7	97	131.5
11/64	.1719	4.366	40	1.5748	300	11.8110	31	42.0	98	132.9
3/16	.1875	4.762	41	1.6142	400	15.7480	32	43.4	99	134.2
	.1968	5.000	42	1.6535	500	19.6850	33	44.7	100	135.6
13/64	.2031	5.159	43	1.6929	600	23.6220	34	46.1	110	149.0
7/32	.2187	5.556	44	1.7323	700	27.5591	35	47.5	115	156.0
15/64	.2344	5.953	45	1.7717	800	31.4961	36	48.8	120	163.0
	.2362	6.000	46	1.8110	900	35.4331	37	50.2	125	170.0
1/4	.2500	6.350	47	1.8504	1000	39.3701	38	51.5	130	176.0
17/64	.2656	6.747	48	1.8898			39	52.9	135	183.0
	.2756	7.000	49	1.9291	<b>INCH POUNDS</b>	<b>NEWTON METERS</b>	40	54.2	140	190.0
9/32	.2812	7.144	50	1.9685	5	0.565	41	55.6	145	197.0
19/64	.2969	7.541	51	2.0079	10	1.13	42	56.9	150	203.0
5/16	.3125	7.937	52	2.0472	15	1.70	43	58.3	155	210.0
	.3150	8.000	53	2.0866	20	2.26	44	59.7	160	217.0
21/64	.3281	8.334	54	2.1260	25	2.83	45	61.0	165	224.0
11/32	.3437	8.731	55	2.1654	30	3.39	46	62.4	170	231.0
	.3543	9.000	56	2.2047	35	3.96	47	63.7	175	237.0
23/64	.3594	9.128	57	2.2441	40	4.52	48	65.0	180	244.0
3/8	.3750	9.525	58	2.2835	45	5.09	49	66.4	185	251.0
25/64	.3906	9.922	59	2.3228	50	5.65	50	67.8	190	258.0
	.3937	10.000	60	2.3622	60	6.78	51	69.1	195	264.0
13/32	.4062	10.319	61	2.4016	70	7.91	52	70.5	200	271.0
27/64	.4219	10.716	62	2.4409	80	9.04	53	71.9	225	305.0
	.4331	11.000	63	2.4803	90	10.17	54	73.2	250	339.0
7/16	.4375	11.112	64	2.5197	100	11.3	55	74.6	275	373.0
29/64	.4531	11.509	65	2.5591	110	12.4	56	75.9	300	407.0
15/32	.4687	11.906	66	2.5984	120	13.6	57	77.3	350	474.0
	.4724	12.000	67	2.6378	130	14.7	58	78.6	400	542.0
31/64	.4844	12.303	68	2.6772	140	15.8	59	80.0		
1/2	.5000	12.700	69	2.7165	150	17.0	60	81.3	<b>HEX SOCKET CONVERSIONS</b> 10mm=0.394" 11mm=0.433" 12mm=0.472" 13mm=0.512" 14mm=0.551" 15mm=0.591" 16mm=0.630" 17mm=0.669" 18mm=0.704" 19mm=0.748" 20mm=0.787" 21mm=0.827"	
	.5118	13.000	70	2.7559	160	18.1	61	82.7		
33/64	.5156	13.097	71	2.7953	170	19.2	62	84.0		
17/32	.5312	13.494	72	2.8346	180	20.3	63	85.4		
35/64	.5469	13.891	73	2.8740	190	21.5	64	86.8		
	.5512	14.000	74	2.9134	200	22.6	65	88.1		
9/16	.5625	14.287	75	2.9528			66	89.5		
37/64	.5781	14.684	76	2.9921	<b>FOOT POUNDS</b>	<b>NEWTON METERS</b>	67	90.8		
	.5906	15.000	77	3.0315	1	1.356	68	92.2		
19/32	.5937	15.081	78	3.0709	2	2.7	69	93.5		
39/64	.6094	15.478	79	3.1102	3	4.0	70	94.9		
5/8	.6250	15.875	80	3.1496	4	5.4	71	96.3		
	.6299	16.000	81	3.1890	5	6.8	72	97.6		
41/64	.6406	16.272	82	3.2283	6	8.1	73	99.0		
21/32	.6562	16.669	83	3.2677	7	9.5	74	100.3		
	.6693	17.000	84	3.3071	8	10.8	75	101.7		
43/64	.6719	17.066	85	3.3465	9	12.2	76	103.0		
11/16	.6875	17.462	86	3.3858	10	13.5	77	104.4		
45/64	.7031	17.859	87	3.4252	11	14.9	78	105.8		
	.7087	18.000	88	3.4646	12	16.3	79	107.1		
23/32	.7187	18.256	89	3.5039	13	17.6	80	108.5		
47/64	.7344	18.653	90	3.5433	14	18.9	81	109.8		
	.7480	19.000	91	3.5827	15	20.3	82	111.2		
3/4	.7500	19.050	92	3.6220	16	21.7	83	112.5		
49/64	.7656	19.447	93	3.6614	17	23.0	84	113.9		
25/32	.7812	19.844								
	.7874	20.000								
51/64	.7969	20.241								
13/16	.8125	20.637								
	.8268	21.000								
53/64	.8281	21.034								
27/32	.8437	21.431								
55/64	.8594	21.828								
	.8661	22.000								
7/8	.8750	22.225								
57/64	.8906	22.622								
	.9055	23.000								
29/32	.9062	23.019								
59/64	.9219	23.416								
15/16	.9375	23.812								
	.9449	24.000								
61/64	.9531	24.209								
31/32	.9687	24.606								
	.9843	25.000								
63/64	.9844	25.003								
	1.0000	25.400								

Inch Lbs. x 0.113=Nm; Nm x 8.849=Inch Lbs.; Ft. Lbs x 1.356=Nm; Nm x 0.737=Ft. Lbs.





250 Snap-on Drive  
 P.O. Box 1596  
 Murphy, North Carolina USA 28906  
 PH: 828.835.9765  
 FAX: 828.835.9685  
 TOLL FREE: 866.259.7291  
 TOLL FREE FAX: 800.722.7236

Belgium  
 Tel.: 32 (0)14 23 19 67  
 Fax: 32 (0)14 23 26 27  
 Email: Industrial.be@snapon.com

Netherlands  
 Tel.: 31 (0)88 0104000  
 Fax: 31 (0)88 0104010  
 Email: Industrial.nl@snapon.com

Latin America  
 Tel.: 786-254-7765  
 Fax: 786-534-9350  
 e-mail: latinamerica.caribbean@snapon.com

Germany  
 Tel.: 49 2104 9509-0  
 Fax: 49 2104 9509-99  
 e-mail: indus.germany@snapon.com

Italy  
 Tel.: 00 39 02 66 04 53 70  
 Fax: 00 39 02 61 29 78 15  
 e-mail: indus.italia@snapon.com

United Kingdom  
 Tel.: 44 (0) 1536-413904  
 Fax: 44 (0) 1536-413874  
 e-mail: industrialuk@snapon.com

Asia  
 Tel.: 65-6451-5570  
 Fax: 65-6451-5574  
 email: esales.sg@snapon.com

Australia  
 Tel.: 61 2 9837 9100  
 Fax: 61 2 9624 2578  
 e-mail: SOTA.customerservice@snapon.com

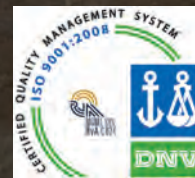

FORM# ZML0014  
 PRINTED IN USA  
 7/19 2500

[www.siouxtools.com](http://www.siouxtools.com)